

CONCEALED DOORFRAMES  
LATENTE, DYNAMIK DOORFRAME  
AND SKIRTING BOARD

JAP







## 04 CONCEALED DOORFRAMES

08 AKTIVE 40/00

20 AKTIVE GLASS

24 AKTIVE 25/15

32 AKTIVE PP

38 DUAL

44 LATENTE COUNTER DOORFRAME

46 DYNAMIK DOORFRAME

52 SKIRTING BOARD

56 FITTINGS FOR DOORFRAMES

DETAIL DECIDES

# DOOR SYSTEM – REVOLVING SYSTEM

The idea behind the door system is to allow architects and apartment designers to comprehensively unify various technical solutions for interior openings for both revolving and sliding doors.

The DOOR SYSTEM is unique and protected by patent for a wide range of utilitarian and industrial designs.

Currently, the solution contains complete ranges for:

- Rotary systems
- Glass walls
- Sliding systems





People say it's what you can't see that counts. Our concealed doorframes are as invisible as the universe's dark matter. All you see is a perfect door — not the mechanism behind it.





## CONCEALED DOORFRAMES

The doorframes are flush with the wall, which allows the doors to perfectly fit the wall. This gives spaces clean lines and even walls with no needless protrusions. The aesthetics are beautiful. The new doorframe technology, hanging 3D adjustable hinges and magnetic counter-plates help conceal these door parts in the wall, so the overall look is not disturbed.

Concealed doorframes are a new apartment concept that give the living space a clean new style.

On the same wall, doors can open inward from one side and outward from the other.

When looking at a wall with a door built into a concealed doorframe, only the door and smooth wall are visible. Concealed doorframes are suitable for masonry and drywall partitions.



# Concealed doorframe model range

## AKTIVE

We offer AKTIVE concealed doorframes in two models: AKTIVE 25/15 and AKTIVE 40/00. The AKTIVE 25/15 doorframe is intended for situations where the door leaf needs to be opened away from the viewing side, and it is necessary to fit the doors with a half track. AKTIVE 40/00 doorframes are for pull opening doors without half tracks toward the viewing side.

Unlined AKTIVE doorframes for revolving doors consist of a visible frame — 2 side panels and 1 door header made of aluminium profile, which joined together form a rigid whole.

Depending on the door weight and hinge type, standard-height doors up to 2100 mm use 2 hinges, and taller doors take 3 hinges. We recommend a lock with a magnetic bolt. The visible frame is fitted with a soft PVC seal for silent closing. Using the right anchoring components, the visible frame is firmly built into the structure.

To lower the risk of cracks, we recommend using the highly flexible, extremely adhesive, easily sandable cement supplied with the doorframe for the drywall partition and woven lath at the masonry partition.

When AKTIVE 40/00 and 25/15 doorframes are used next to each other and the same visual height is required, it is necessary to add 12 mm to the height of the AKTIVE 25/15 doorframe.

# Concealed doorframes AKTIVE MODEL

AKTIVE concealed doorframe





We make two AKTIVE 25/15 models for push-opening doors — half-track door with 15 mm half tracks and AKTIVE 40/00 for pull-opening doors — doors without half tracks.

- For doors 40 mm thick
- Used for DRYWALL and masonry
- The construction opening for the AKTIVE concealed doorframe is the same as for a traditional doorframe
- The doorframe is equipped with two hinges (for door heights up to 2100 mm) and a counter-plate, which combined with the lock for the door leaf; 3 hinges or more are used for heavier doors
- The doorframe is fitted with a soft PVC seal for silent closing
- We also produce doorframes without door headers or for sloped ground spaces
- We offer doorframe heights to 3,700 mm
- We also produce nonstandard dimensions, both widths and heights
- The doorframes are made of anodized aluminium or in RAL K7, NCS and CREATIVE METALLIC colours
- The warranty on doorframes is 5 years
- Made in the Czech Republic

AKTIVE 40/00



AKTIVE 25/15



# Concealed doorframe

## AKTIVE 40/00

### For wooden doors

All dimensions are in millimetres.

Thickness of door leaf – non-rebated: 40.

#### AKTIVE 40/00 1970 mm

Height of net passage after installation of doorframe (J): 1970.

Total height of doorframe (H): 2011.

Standard height of the door leaf (L): 1972.

Net passage after installing doorframe D x J	Total dimensions of revolving doorframe E x H*	Standard dimensions of revolving leaf C x L	Recommended dimensions of rough construction opening
606 x 1970	688 x 2011	624 x 1972	708 x 2021
706 x 1970	788 x 2011	724 x 1972	808 x 2021
806 x 1970	888 x 2011	824 x 1972	908 x 2021
906 x 1970	988 x 2011	924 x 1972	1008 x 2021
1006 x 1970	1088 x 2011	1024 x 1972	1108 x 2021

#### AKTIVE 40/00 2100 mm

Height of net passage after installation of doorframe (J): 2100.

Total height of doorframe (H): 2141.

Standard height of the door leaf (L): 2102.

Net passage after installing doorframe D x J	Total dimensions of revolving doorframe E x H*	Standard dimensions of revolving leaf C x L	Recommended dimensions of rough construction opening
606 x 2100	688 x 2141	624 x 2102	708 x 2151
706 x 2100	788 x 2141	724 x 2102	808 x 2151
806 x 2100	888 x 2141	824 x 2102	908 x 2151
906 x 2100	988 x 2141	924 x 2102	1008 x 2151
1006 x 2100	1088 x 2141	1024 x 2102	1108 x 2151

\* external dimensions of doorframe, including anchors

C – width of door leaf

L – door leaf height

E – total width of doorframe

H – total height of doorframe

D – net walk-through width of doorframe

J – net walk-through height of doorframe







# Concealed doorframe

## AKTIVE 40/00

### For wooden doors

The gap between the doorframe and leaf is 3 mm, and the gap between the floor and door leaf is 7 mm.

Standard clear passage is 1958, 1970, 2088 or 2100 mm.

Nonstandard dimensions from 1975 mm to 3700 mm.

The doorframe is intended for a final minimum partition thickness of 100 mm or greater. The hole must be provided with a lintel — the doorframe cannot bear a load.

We offer a double-leaf version of AKTIVE 40/00 for passage widths of 1250–2050 mm.

#### METAL FITTINGS

---

- TECTUS 340 hinge
- Argenta NEO – M6 hinge
- M&T magnetically adjustable counter-plate
- HOBES short magnetic counter-plate
- HOBES long magnetic counter-plate, long for locking
- HOBES magnetic lock (cylindrical, deadbolt, WC)
- M&T magnetic lock (cylindrical, deadbolt, WC)

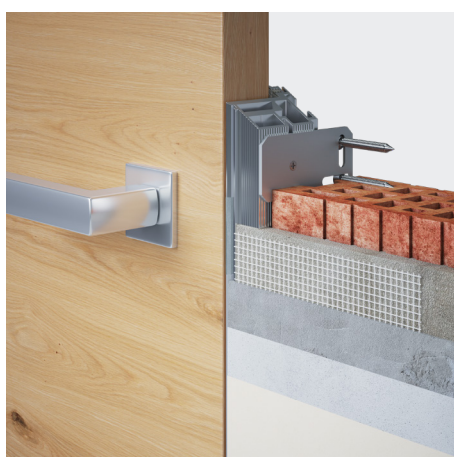
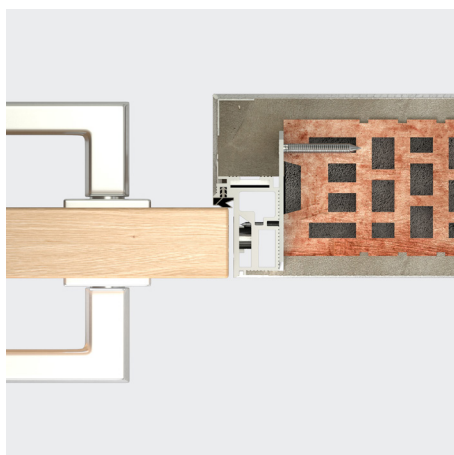
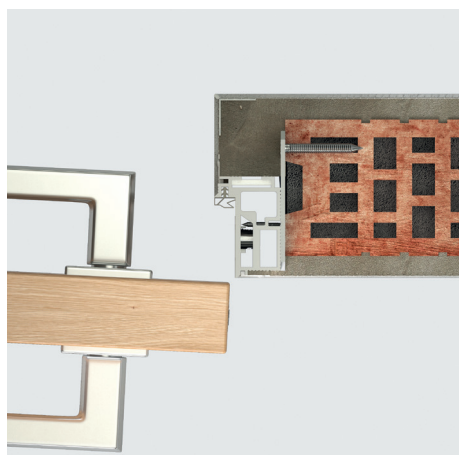

# DOORFRAME SOLUTION OPTIONS

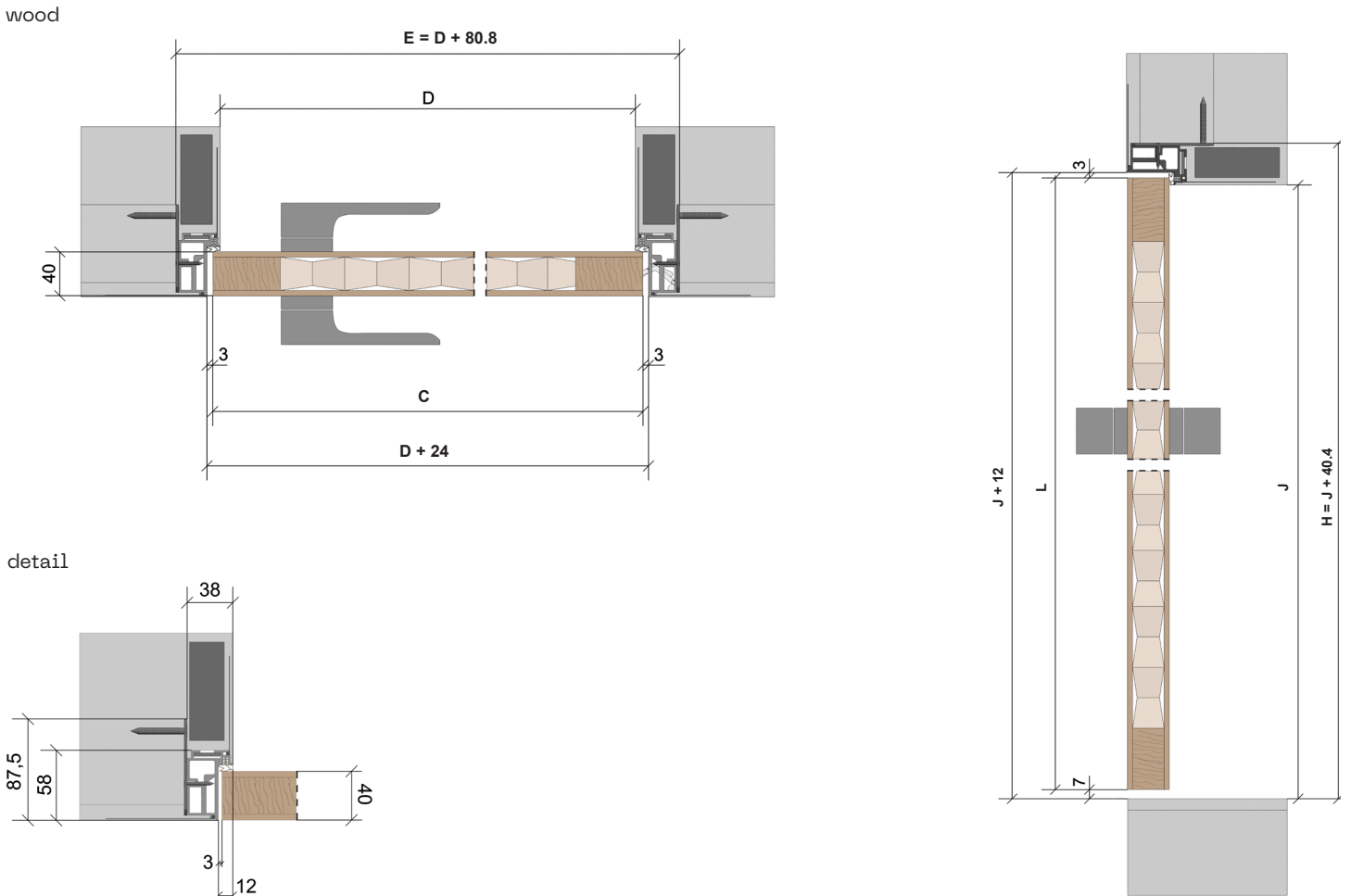
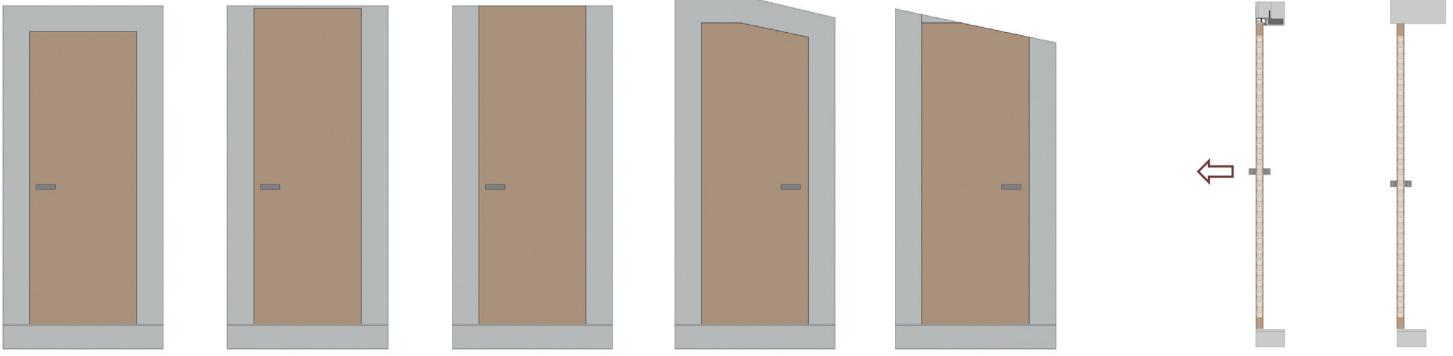

- C – width of door leaf
- L – door leaf height
- E – total width of doorframe
- H – total height of doorframe
- D – net walk-through width of doorframe
- J – net walk-through height of doorframe

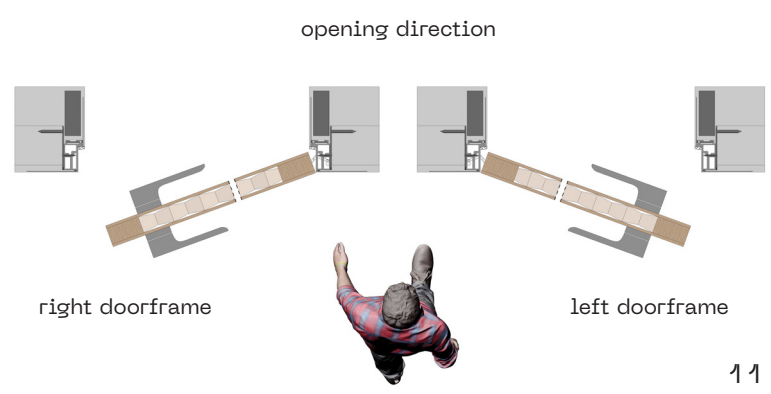

# Concealed doorframe

## AKTIVE 40/00

### For MASTER doors

All dimensions are in millimetres.

Thickness of door leaf – non-rebated: 40.

#### AKTIVE 40/00 1970 mm

Height of net passage after installation of doorframe (J): 1970.

Total height of doorframe (H): 2011.

Standard height of the door leaf (L): 1972.

Net passage after installing doorframe D x J	Total dimensions of revolving doorframe E x H*	Standard dimensions of revolving leaf C x L	Recommended dimensions of rough construction opening
606 x 1970	688 x 2011	624 x 1972	708 x 2021
706 x 1970	788 x 2011	724 x 1972	808 x 2021
806 x 1970	888 x 2011	824 x 1972	908 x 2021
906 x 1970	988 x 2011	924 x 1972	1008 x 2021
1006 x 1970	1088 x 2011	1024 x 1972	1108 x 2021

#### AKTIVE 40/00 2100 mm

Height of net passage after installation of doorframe (J): 2100.

Total height of doorframe (H): 2141.

Standard height of the door leaf (L): 2102.

Net passage after installing doorframe D x J	Total dimensions of revolving doorframe E x H*	Standard dimensions of revolving leaf C x L	Recommended dimensions of rough construction opening
606 x 2100	688 x 2141	624 x 2102	708 x 2151
706 x 2100	788 x 2141	724 x 2102	808 x 2151
806 x 2100	888 x 2141	824 x 2102	908 x 2151
906 x 2100	988 x 2141	924 x 2102	1008 x 2151
1006 x 2100	1088 x 2141	1024 x 2102	1108 x 2151

\* external dimensions of doorframe, including anchors

C – width of door leaf

L – door leaf height

E – total width of doorframe

H – total height of doorframe

D – net walk-through width of doorframe

J – net walk-through height of doorframe





# Concealed doorframe

## AKTIVE 40/00

### For MASTER doors

The gap between the doorframe and leaf is 3 mm, and the gap between the floor and door leaf is 7 mm.

Standard clear passage is 1958, 1970, 2088 or 2100 mm.

Nonstandard dimensions from 1975 mm to 3700 mm. The doorframe is intended for a final minimum partition thickness of 100 mm or greater. The hole must be provided with a lintel — the doorframe cannot bear a load.

#### METAL FITTINGS

---

- Argenta NEO – M6 hinge
- HOBES short magnetic counter-plate
- HOBES long magnetic counter-plate, long for locking
- HOBES magnetic lock (cylindrical, deadbolt, WC)
- choice of door handle

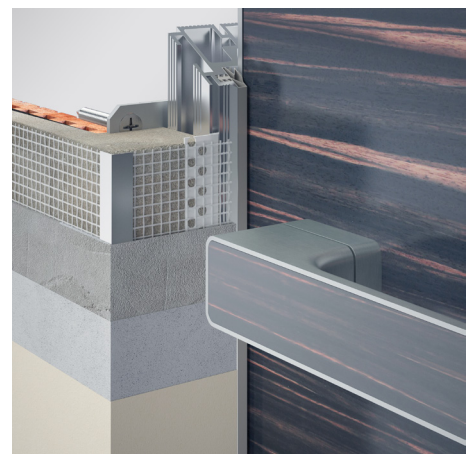
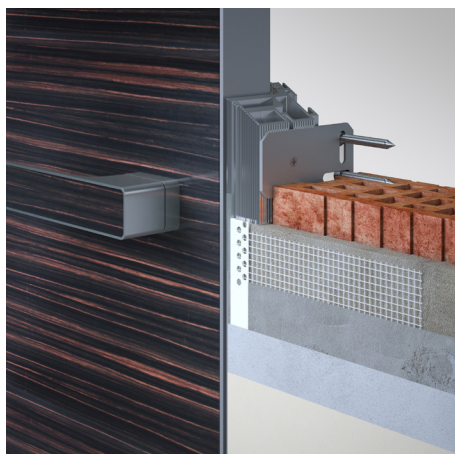
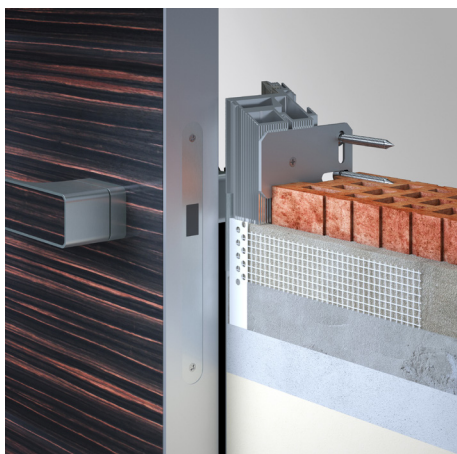
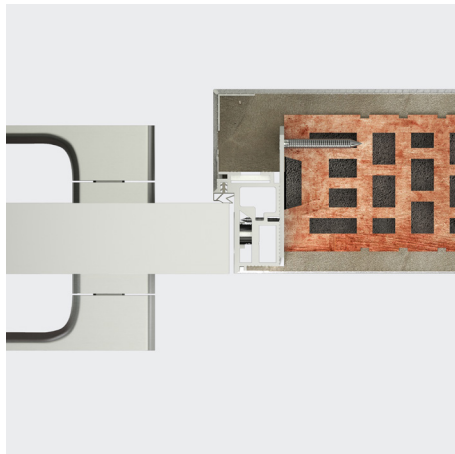
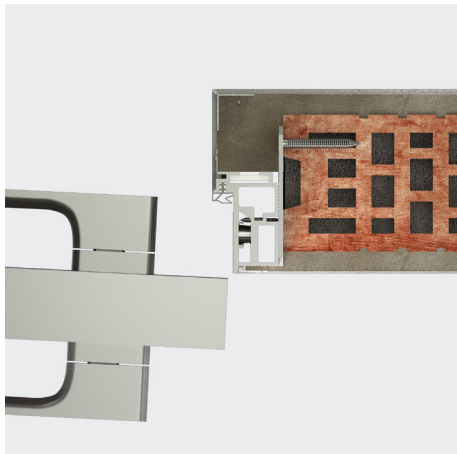



# DOORFRAME SOLUTION OPTIONS

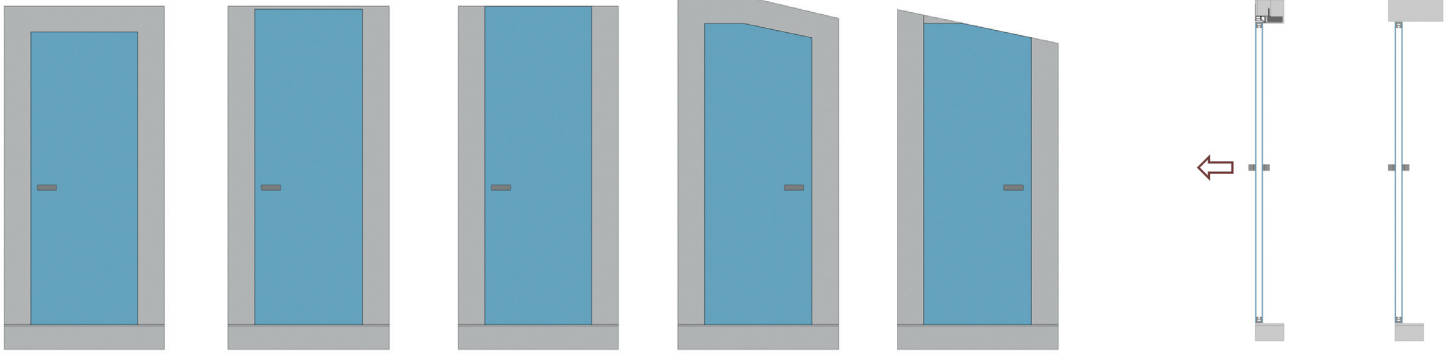

MASTER

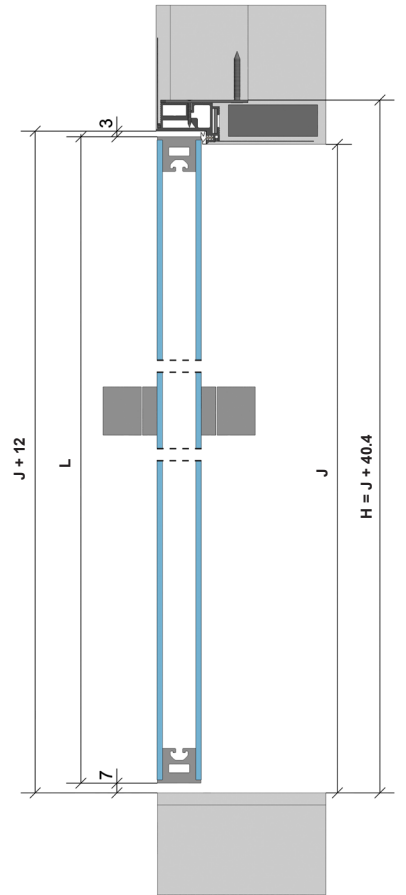
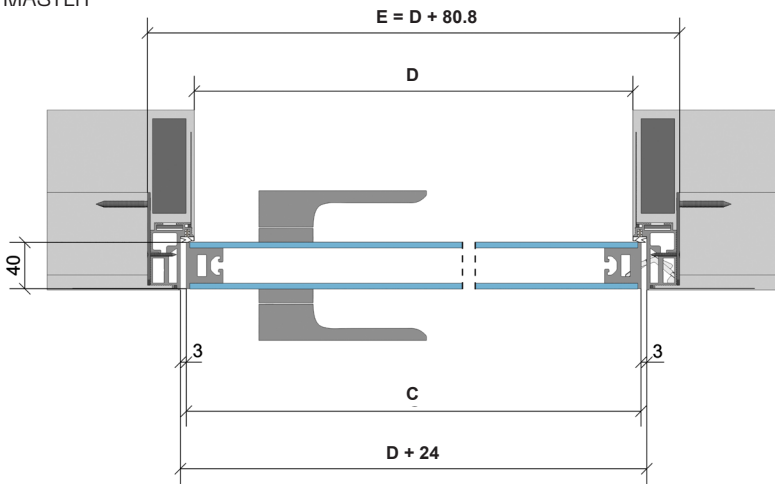

detail

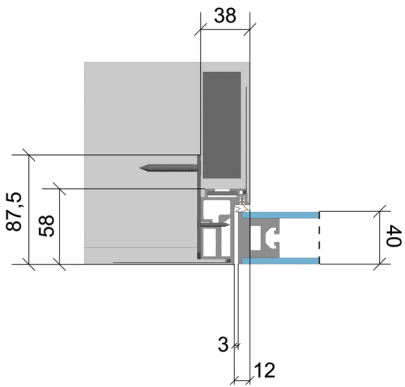

- C – width of door leaf
- L – door leaf height
- E – total width of doorframe
- H – total height of doorframe
- D – net walk-through width of doorframe
- J – net walk-through height of doorframe

opening direction

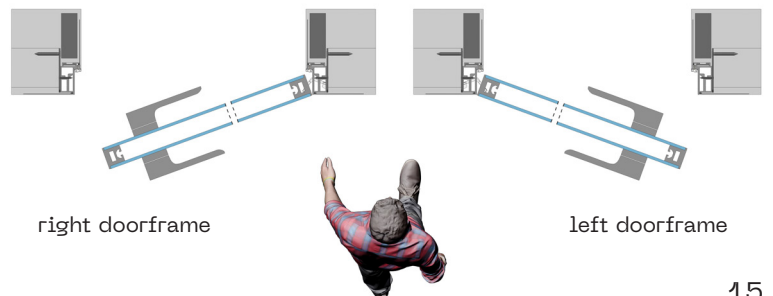

# Concealed doorframe

## AKTIVE 40/00

### For MASTER doors

All dimensions are in millimetres.

Thickness of door leaf – non-rebated: 40.

#### AKTIVE 40/00 1970 mm

Height of net passage after installation of doorframe (J): 1970.

Total height of doorframe (H): 2011.

Standard height of the door leaf (L): 1972.

Net passage after installing doorframe D x J	Total dimensions of revolving doorframe E x H*	Standard dimensions of revolving leaf C x L	Recommended dimensions of rough construction opening
606 x 1970	688 x 2011	622 x 1972	708 x 2021
706 x 1970	788 x 2011	722 x 1972	808 x 2021
806 x 1970	888 x 2011	822 x 1972	908 x 2021
906 x 1970	988 x 2011	922 x 1972	1008 x 2021
1006 x 1970	1088 x 2011	1022 x 1972	1108 x 2021

#### AKTIVE 40/00 2100 mm

Height of net passage after installation of doorframe (J): 2100.

Total height of doorframe (H): 2141.

Standard height of the door leaf (L): 2102.

Net passage after installing doorframe D x J	Total dimensions of revolving doorframe E x H*	Standard dimensions of revolving leaf C x L	Recommended dimensions of rough construction opening
606 x 2100	688 x 2141	622 x 2102	708 x 2151
706 x 2100	788 x 2141	722 x 2102	808 x 2151
806 x 2100	888 x 2141	822 x 2102	908 x 2151
906 x 2100	988 x 2141	922 x 2102	1008 x 2151
1006 x 2100	1088 x 2141	1022 x 2102	1108 x 2151

\* external dimensions of doorframe, including anchors

C – width of door leaf

L – door leaf height

E – total width of doorframe

H – total height of doorframe

D – net walk-through width of doorframe

J – net walk-through height of doorframe





# Concealed doorframe

## AKTIVE 40/00

### For MASTER doors

The gap between the doorframe and leaf is 4 mm, and the gap between the floor and door leaf is 6 mm.

Standard clear passage is 1958, 1970, 2088 or 2100 mm.

Nonstandard dimensions from 1975 mm to 3700 mm.

The doorframe is intended for a final minimum partition thickness of 100 mm or greater. The hole must be provided with a lintel — the doorframe cannot bear a load.

#### METAL FITTINGS

---

- SFS CAB SQUARE pin hinge
- BONAITI magnetic counter-plate
- FINE door handle, including BONAITI door handle
- GRANDE door handle, including BONAITI door handle

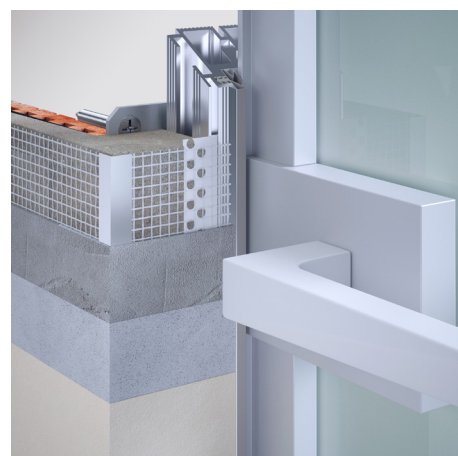
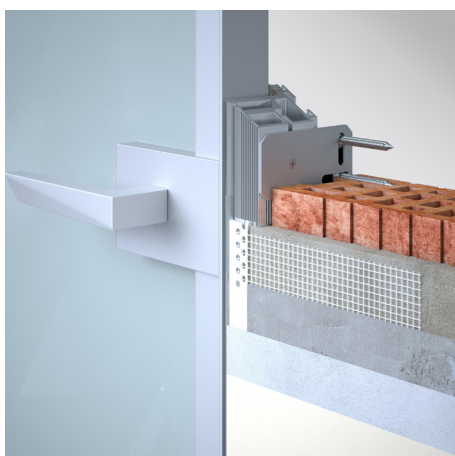
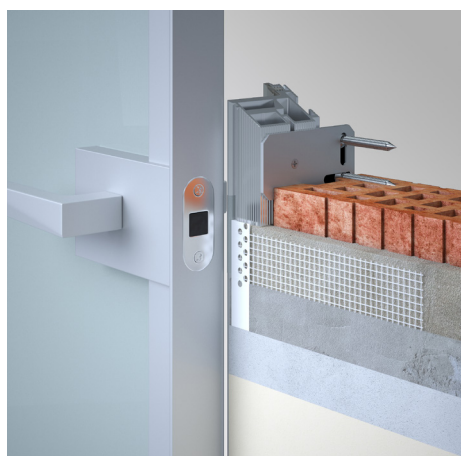
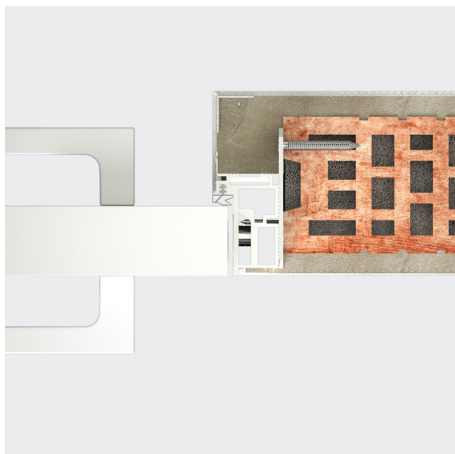
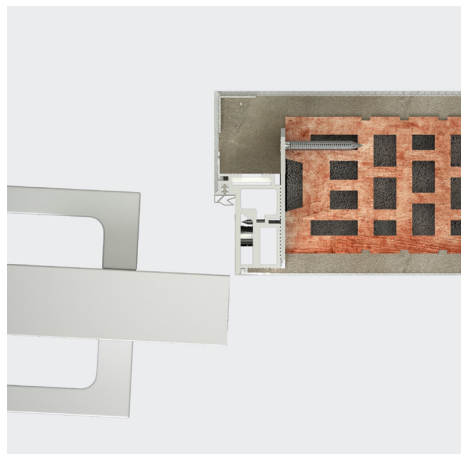

# DOORFRAME SOLUTION OPTIONS

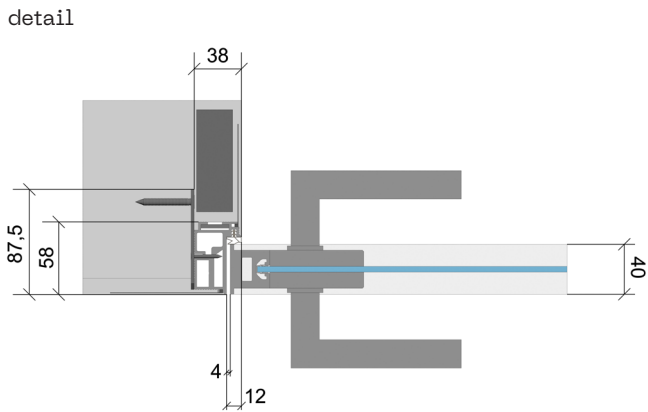
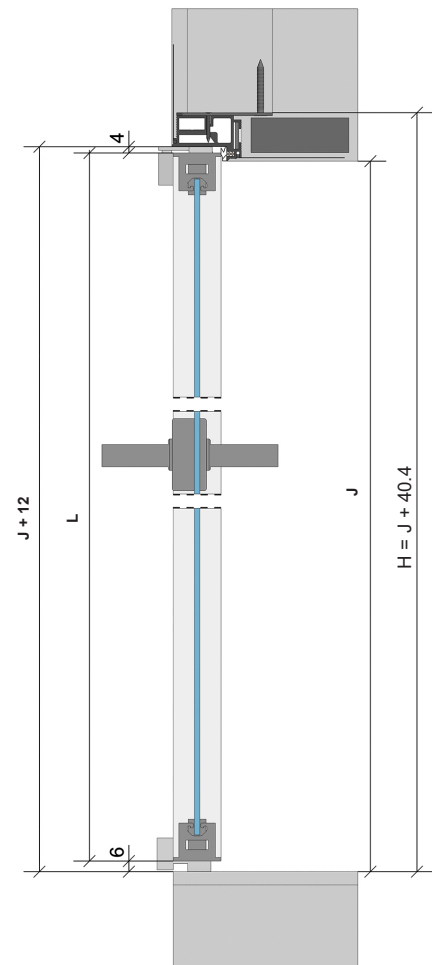
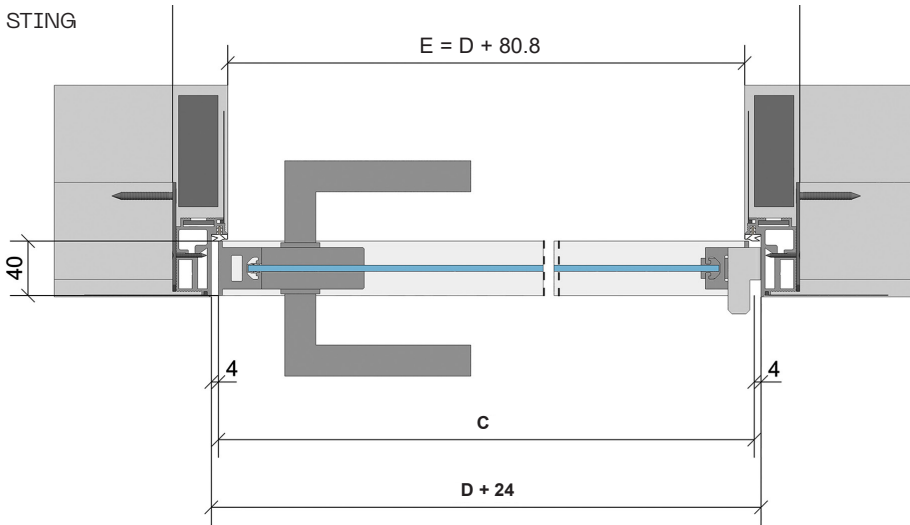
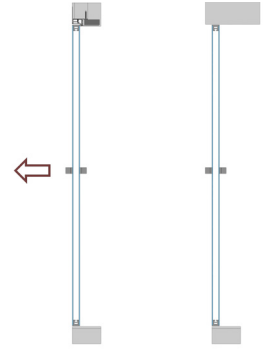
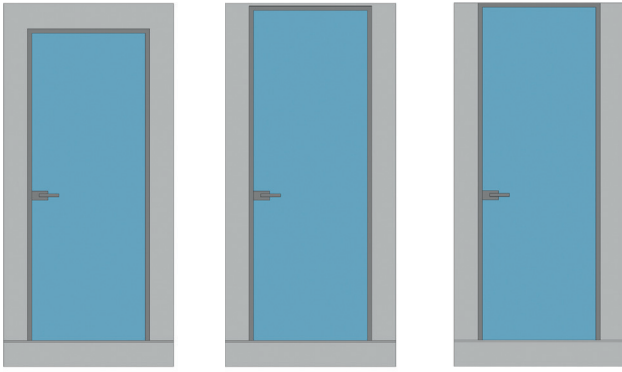

- C – width of door leaf
- L – door leaf height
- E – total width of doorframe
- H – total height of doorframe
- D – net walk-through width of doorframe
- J – net walk-through height of doorframe

opening direction

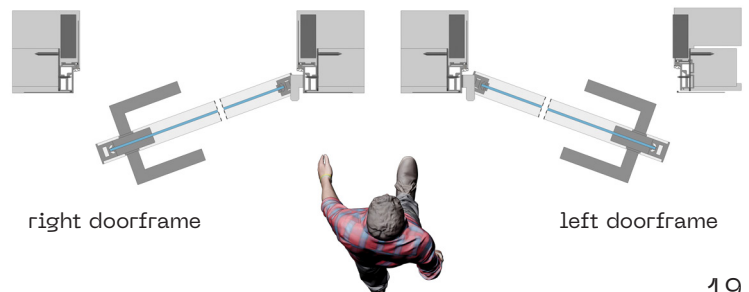



# Concealed doorframe

## AKTIVE GLASS

### For glass doors

All dimensions are in millimetres.

Thickness of door leaf – glass: 10.

#### AKTIVE GLASS 1970 mm

Height of net passage after installation of doorframe (J): 1970.

Total height of doorframe (H): 2008.

Standard height of the door leaf (L): 1972.

Net passage after installing doorframe D x J	Total dimensions of revolving doorframe E x H*	Standard dimensions of revolving leaf C x L	Recommended dimensions of rough construction opening
606 x 1970	687 x 2008	622 x 1972	700 x 2018
706 x 1970	787 x 2008	722 x 1972	800 x 2018
806 x 1970	887 x 2008	822 x 1972	900 x 2018
906 x 1970	987 x 2008	922 x 1972	1000 x 2018
1006 x 1970	1087 x 2008	1022 x 1972	1100 x 2018

#### AKTIVE GLASS 2100 mm

Height of net passage after installation of doorframe (J): 2100.

Total height of doorframe (H): 2138.

Standard height of the door leaf (L): 2102.

Net passage after installing doorframe D x J	Total dimensions of revolving doorframe E x H*	Standard dimensions of revolving leaf C x L	Recommended dimensions of rough construction opening
606 x 2100	687 x 2138	622 x 2102	700 x 2148
706 x 2100	787 x 2138	722 x 2102	800 x 2148
806 x 2100	887 x 2138	822 x 2102	900 x 2148
906 x 2100	987 x 2138	922 x 2102	1000 x 2148
1006 x 2100	1087 x 2138	1022 x 2102	1100 x 2148

\* external dimensions of doorframe, including anchors

C – width of door leaf

L – door leaf height

E – total width of doorframe

H – total height of doorframe

D – net walk-through width of doorframe

J – net walk-through height of doorframe





# Concealed doorframe

## AKTIVE GLASS

### For glass doors

The gap between the doorframe and leaf is 4 mm, and the gap between the floor and door leaf is 8 mm.

Standard clear passage is 1970 mm and 2100 mm. Nonstandard dimensions from 1975 mm to 2800 mm.

When using anchors, the doorframe is intended for a final partition thickness of 100 mm or greater. The hole must be provided with a lintel — the doorframe cannot bear a load.

#### METAL FITTINGS

---

- TECTUS Glass TEG 310 hinge
- TECTUS KC 50 magnetic counter-plate
- choice of handle

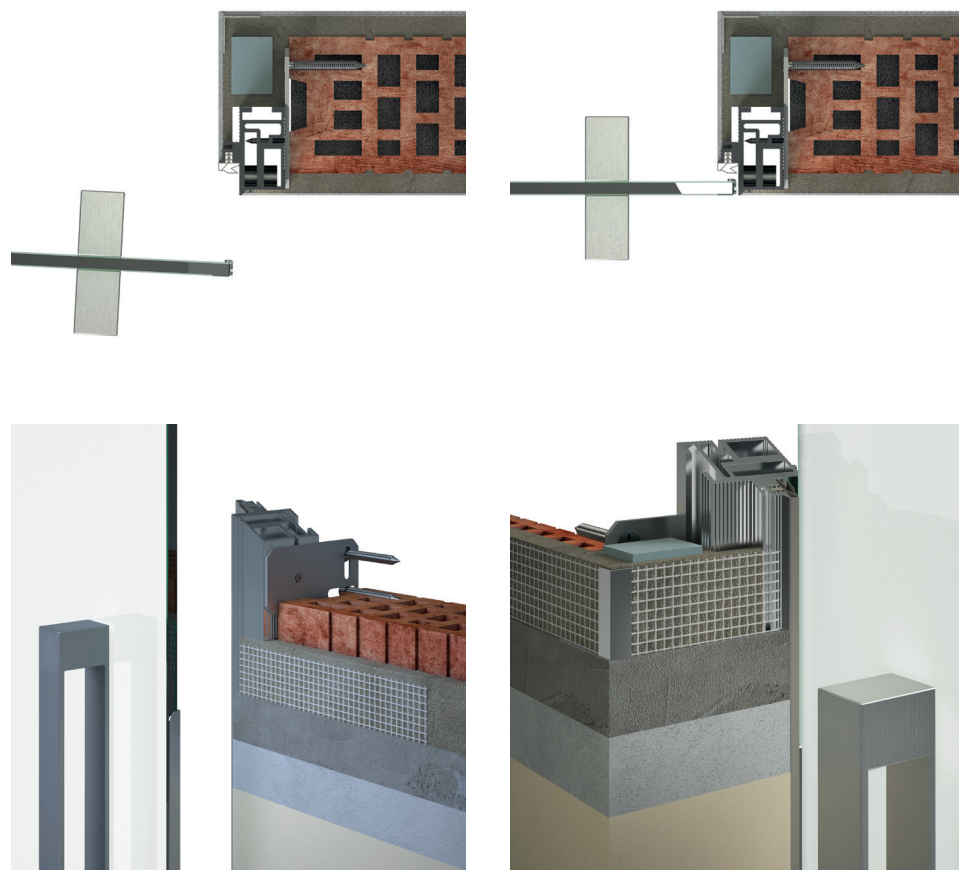



# DOORFRAME SOLUTION OPTIONS

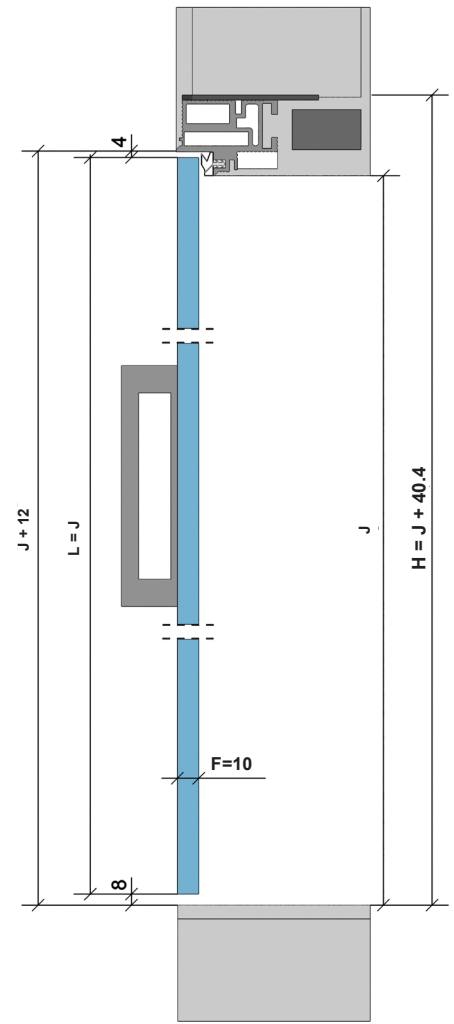
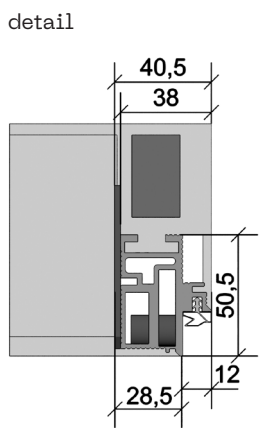
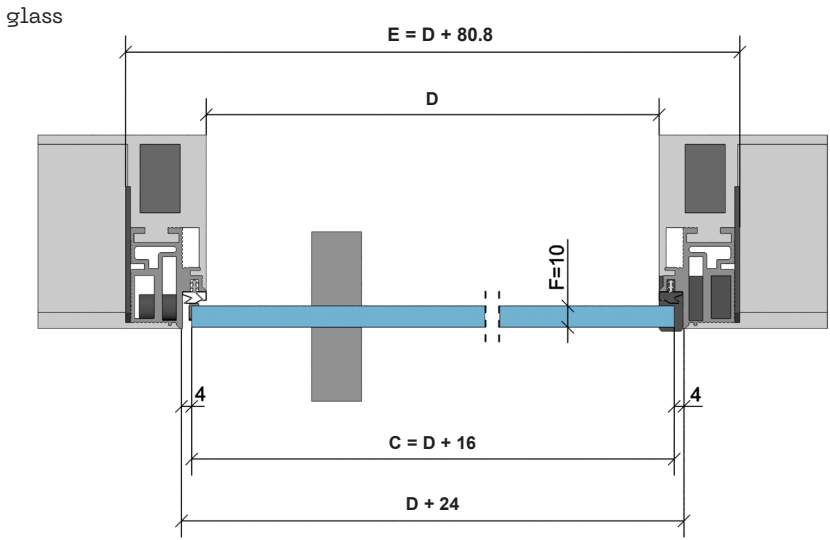
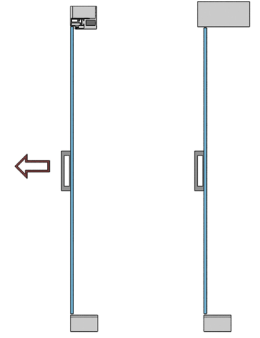
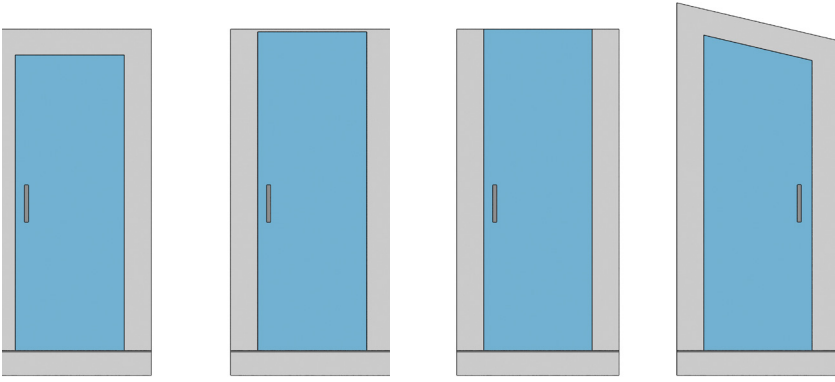

- C – width of door leaf
- L – door leaf height
- E – total width of doorframe
- H – total height of doorframe
- D – net walk-through width of doorframe
- J – net walk-through height of doorframe

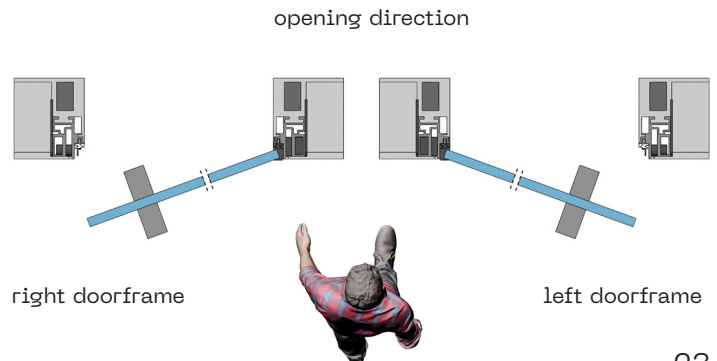

# Concealed doorframe

## AKTIVE 25/15

### For wooden doors

All dimensions are in millimetres.

Thickness of door leaf – rebated 40.

#### AKTIVE 25/15 1970 mm

Height of net passage after installation of doorframe (J): 1982.

Total height of doorframe (H): 2026.

Standard height of the door leaf (L): 1987.

Net passage after installing doorframe D x J	Total dimensions of revolving doorframe E x H*	Standard dimensions of revolving leaf C x L	Recommended dimensions of rough construction opening
630 x 1982	718 x 2026	654 x 1987	738 x 2036
730 x 1982	818 x 2026	754 x 1987	838 x 2036
830 x 1982	918 x 2026	854 x 1987	938 x 2036
930 x 1982	1018 x 2026	954 x 1987	1038 x 2036
1030 x 1982	1118 x 2026	1054 x 1987	1138 x 2036

#### AKTIVE 25/15 2100 mm

Height of net passage after installation of doorframe (J): 2112.

Total height of doorframe (H): 2156.

Standard height of the door leaf (L): 2117.

Net passage after installing doorframe D x J	Total dimensions of revolving doorframe E x H*	Standard dimensions of revolving leaf C x L	Recommended dimensions of rough construction opening
630 x 2112	718 x 2156	654 x 2117	738 x 2166
730 x 2112	818 x 2156	754 x 2117	838 x 2166
830 x 2112	918 x 2156	854 x 2117	938 x 2166
930 x 2112	1018 x 2156	954 x 2117	1038 x 2166
1030 x 2112	1118 x 2156	1054 x 2117	1138 x 2166

\* external dimensions of doorframe, including anchors

C – width of door leaf

L – door leaf height

E – total width of doorframe

H – total height of doorframe

D – net walk-through width of doorframe

J – net walk-through height of doorframe





# Concealed doorframe

## AKTIVE 25/15

### For wooden doors

The gap between the doorframe and leaf is 3 mm, and the gap between the floor and door leaf is 7 mm.

Standard clear passage is 1970, 1982, 2100 or 2112 mm.

Nonstandard dimensions from 1975 mm to 3700 mm.

The doorframe is intended for a final minimum partition thickness of 100 mm or greater. The hole must be provided with a lintel — the doorframe cannot bear a load.

We offer a double-leaf version of AKTIVE 25/15 for passage widths of 1250–2050 mm.

#### METAL FITTINGS

---

- TECTUS 240 hinge
- HOBES short magnetic counter-plate
- HOBES long magnetic counter-plate, long for locking
- HOBES magnetic lock (cylindrical, deadbolt, WC)
- M&T magnetic lock (cylindrical, deadbolt, WC)

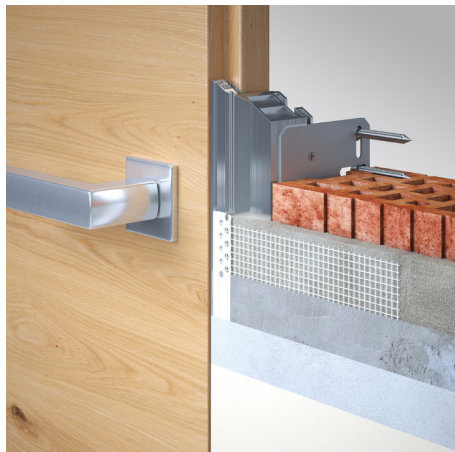
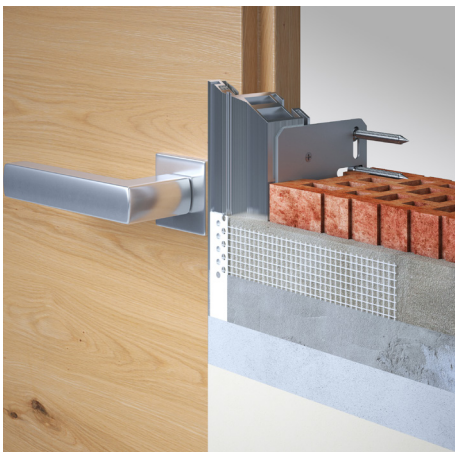
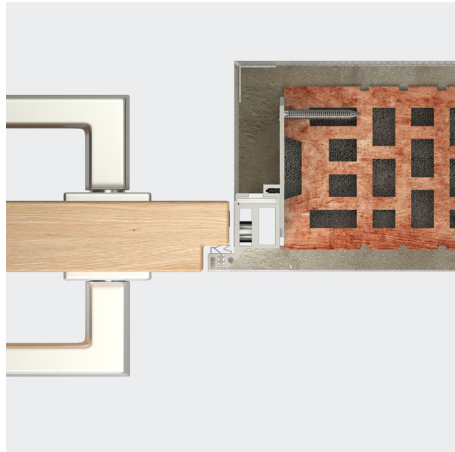
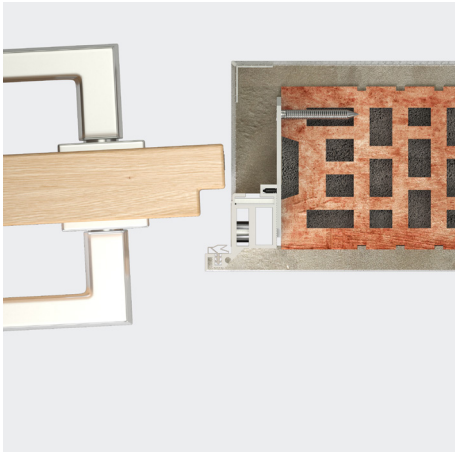

# DOORFRAME SOLUTION OPTIONS

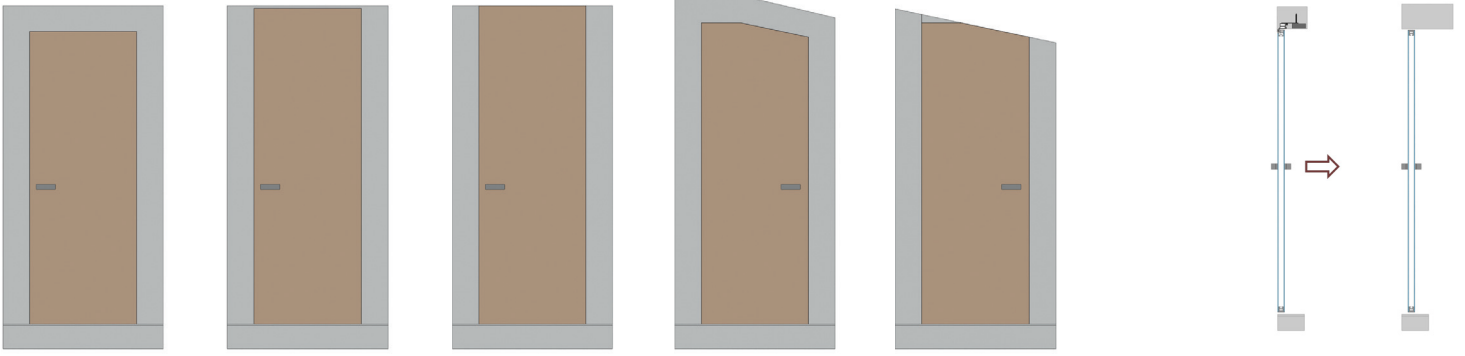

wood

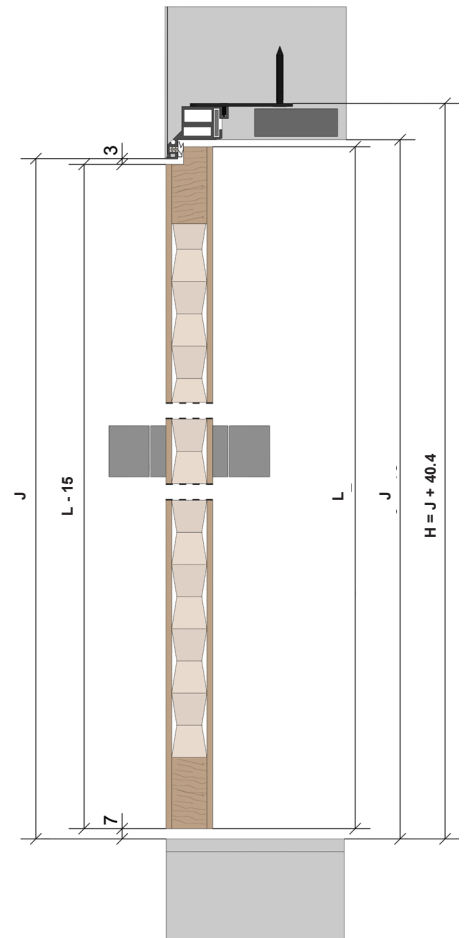
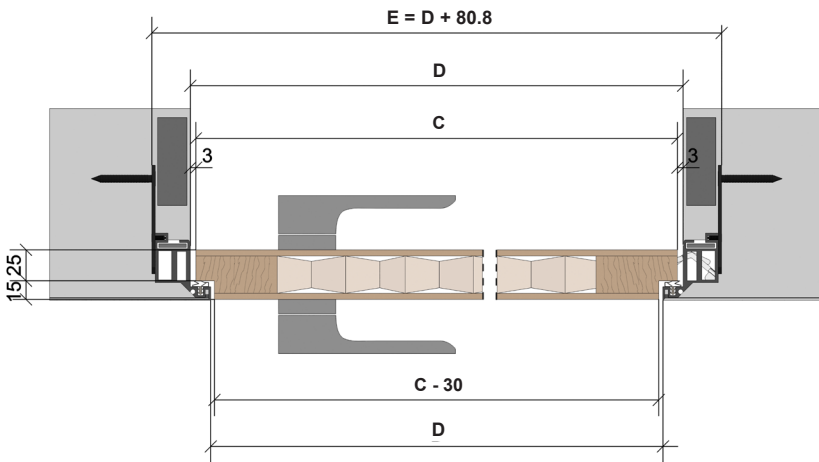

detail

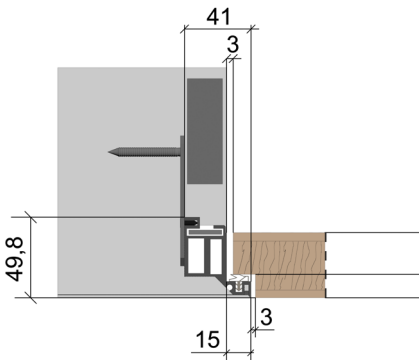

- C – width of door leaf
- L – door leaf height
- E – total width of doorframe
- H – total height of doorframe
- D – net walk-through width of doorframe
- J – net walk-through height of doorframe

opening direction

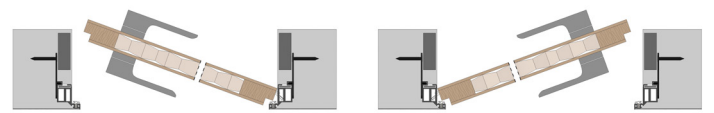

right doorframe

left doorframe



# Concealed doorframe

## AKTIVE 25/15

### For MASTER doors

All dimensions are in millimetres.  
Thickness of door leaf – rebated 40.

#### AKTIVE 25/15 1970 mm

Height of net passage after installation of doorframe (J): 1982.

Total height of doorframe (H): 2026.

Standard height of the door leaf (L): 1987.

Net passage after installing doorframe D x J	Total dimensions of revolving doorframe E x H*	Standard dimensions of revolving leaf C x L	Recommended dimensions of rough construction opening
630 x 1982	718 x 2026	654 x 1987	738 x 2036
730 x 1982	818 x 2026	754 x 1987	838 x 2036
830 x 1982	918 x 2026	854 x 1987	938 x 2036
930 x 1982	1018 x 2026	954 x 1987	1038 x 2036
1030 x 1982	1118 x 2026	1054 x 1987	1138 x 2036

#### AKTIVE 25/15 2100 mm

Height of net passage after installation of doorframe (J): 2112.

Total height of doorframe (H): 2156.

Standard height of the door leaf (L): 2117.

Net passage after installing doorframe D x J	Total dimensions of revolving doorframe E x H*	Standard dimensions of revolving leaf C x L	Recommended dimensions of rough construction opening
630 x 2112	718 x 2156	654 x 2117	738 x 2166
730 x 2112	818 x 2156	754 x 2117	838 x 2166
830 x 2112	918 x 2156	854 x 2117	938 x 2166
930 x 2112	1018 x 2156	954 x 2117	1038 x 2166
1030 x 2112	1118 x 2156	1054 x 2117	1138 x 2166

\* external dimensions of doorframe, including anchors

C – width of door leaf

L – door leaf height

E – total width of doorframe

H – total height of doorframe

D – net walk-through width of doorframe

J – net walk-through height of doorframe







# Concealed doorframe

## AKTIVE 25/15

### For MASTER doors

The gap between the doorframe and leaf is 3 mm, and the gap between the floor and door leaf is 7 mm.

Standard clear passage is 1970, 1982, 2100 or 2112 mm.

Nonstandard dimensions from 1975 mm to 3700 mm. The doorframe is intended for a final minimum partition thickness of 100 mm or greater.

The hole must be provided with a lintel — the doorframe cannot bear a load.

#### METAL FITTINGS

---

- TECTUS 240 hinge
- Hobes short magnetic counter-plate
- HOBES long magnetic counter-plate, long for locking
- Hobes magnetic lock (cylindrical, deadbolt, WC)
- choice of door handle

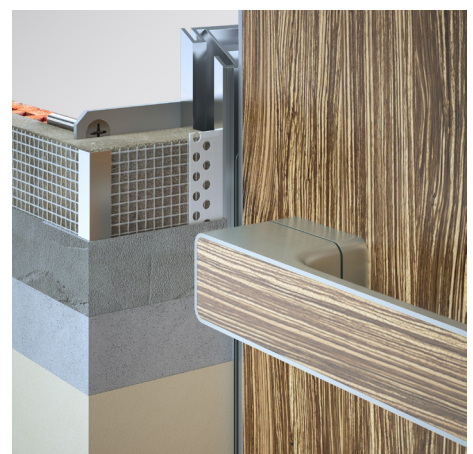
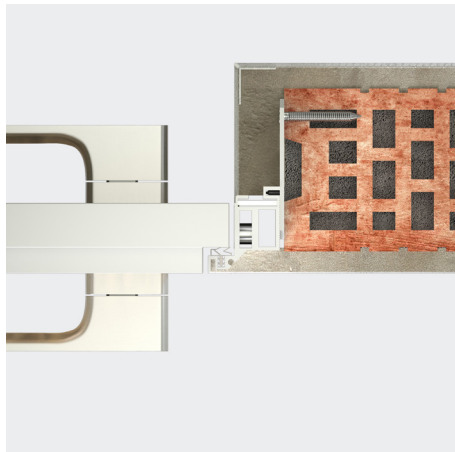
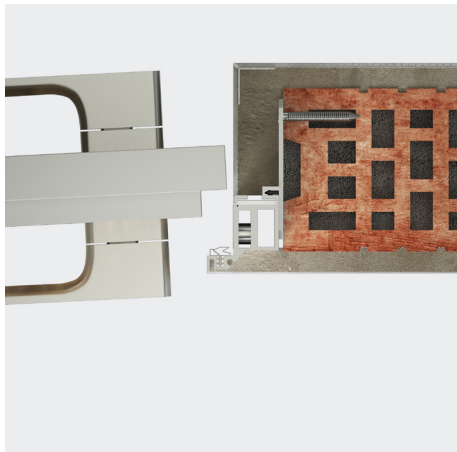

# DOORFRAME SOLUTION OPTIONS

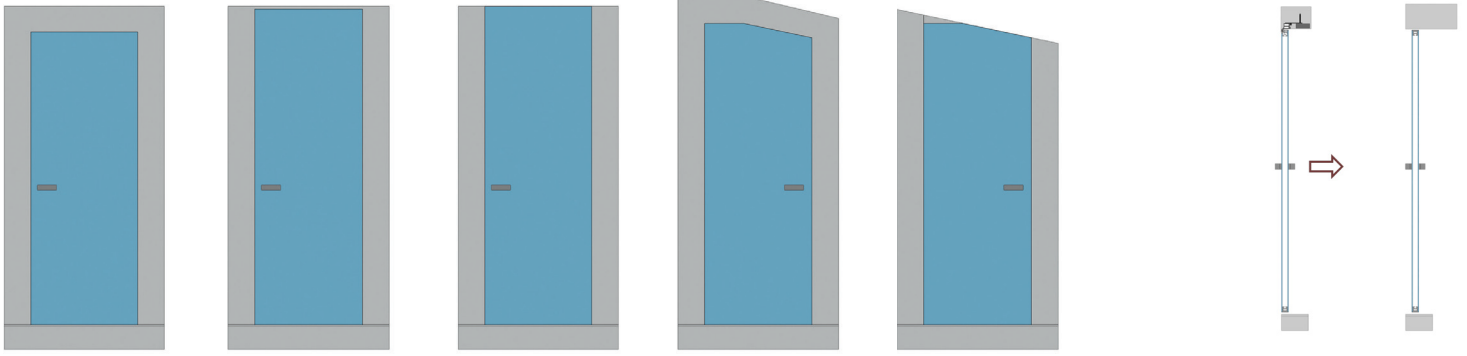

MASTER

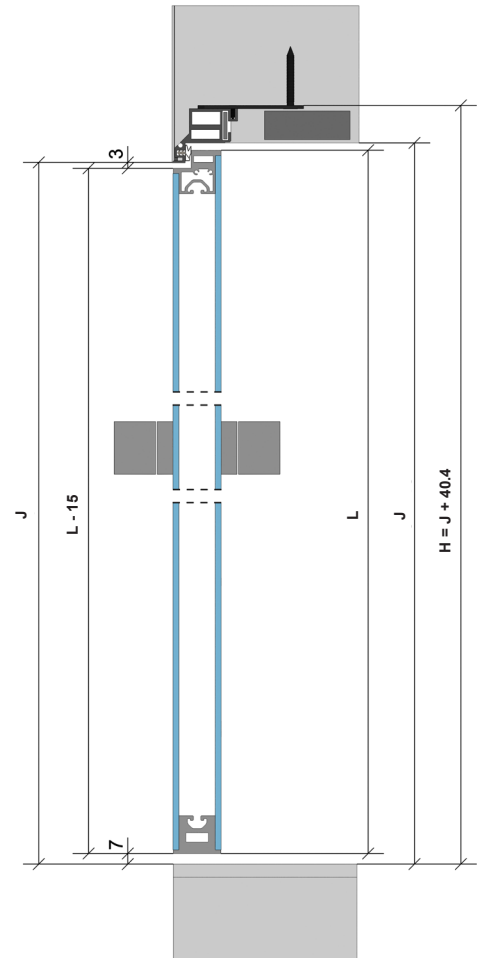
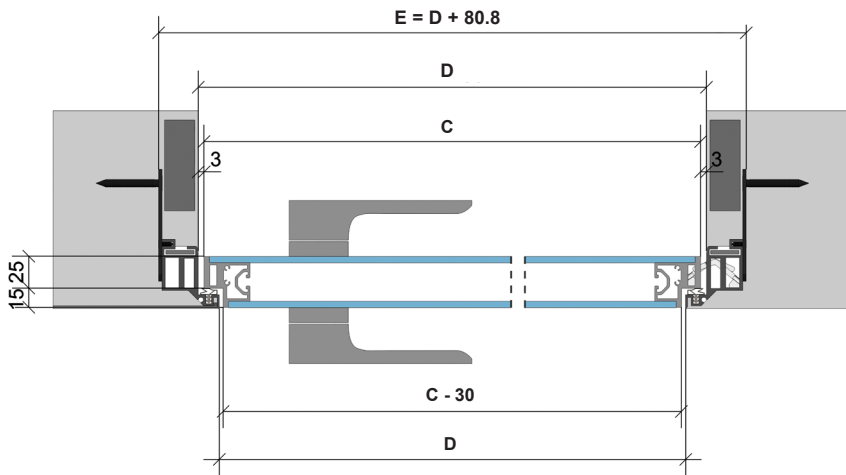

detail

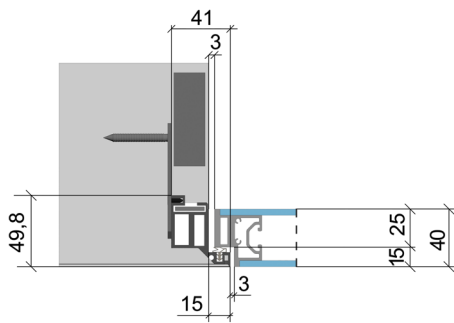

- C – width of door leaf
- L – door leaf height
- E – total width of doorframe
- H – total height of doorframe
- D – net walk-through width of doorframe
- J – net walk-through height of doorframe

opening direction

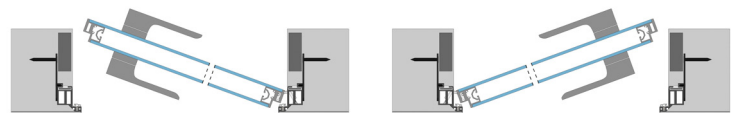

right doorframe



left doorframe



# Concealed doorframe AKTIVE PP MODEL for glass doors

AKTIVE PP concealed doorframe



# This model of concealed doorframe is fire and break-in resistant.

- This model conforms to flame-resistance standard EI30 and safety standard RC2
- Intended for SAPELI break-in resistant, flame-resistant doors 40 mm thick
- The doorframe can be ordered only from the SAPELI sales network
- Only AKTIVE 40/00 for pull opening (traditional) non-rebated doors
- Meet the standard both in masonry and DRYWALL partitions
- The doorframe is equipped with 2 hinges and a counter-plate
- For doors weighing more, hinges are added as needed
- Hinge meeting the PP standard are TECTUS 340
- The construction opening for the AKTIVE PP concealed doorframe is larger than for a traditional doorframe
- The doorframe is fitted with a soft PVC seal for silent closing
- PP cannot be added without a door header, or with a slanted end toward the attic
- The doorframes are made of anodized aluminium or in RAL K7, NCS and CREATIVE METALLIC colours
- 5-year warranty
- Made in the Czech Republic

AKTIVE PP 40/00



# Concealed doorframe

## AKTIVE PP 40/00

### for SAPELI flame-resistant doors

All dimensions are in millimetres.

Thickness of door leaf – non-rebated: 40.

#### AKTIVE PP 40/00 1970 mm

Height of net passage after installation of doorframe (J): 1970.

Total height of doorframe (H): 2029.5.

Standard height of the door leaf (L): 1972.

Net passage after installing doorframe D x J	Total dimensions of revolving doorframe E x H*	Standard dimensions of revolving leaf C x L	Recommended dimensions of rough construction opening
606 x 1970	725 x 2029.5	624 x 1972	745 x 2039.5
706 x 1970	825 x 2029.5	724 x 1972	845 x 2039.5
806 x 1970	925 x 2029.5	824 x 1972	945 x 2039.5
906 x 1970	1025 x 2029.5	924 x 1972	1045 x 2039.5
1006 x 1970	1125 x 2029.5	1024 x 1972	1145 x 2039.5

#### AKTIVE PP 40/00 2100 mm

Height of net passage after installation of doorframe (J): 2100.

Total height of doorframe (H): 2159.5.

Standard height of the door leaf (L): 2102.

Net passage after installing doorframe D x J	Total dimensions of revolving doorframe E x H*	Standard dimensions of revolving leaf C x L	Recommended dimensions of rough construction opening
606 x 2100	725 x 2159.5	624 x 2102	745 x 2169.5
706 x 2100	825 x 2159.5	724 x 2102	845 x 2169.5
806 x 2100	925 x 2159.5	824 x 2102	945 x 2169.5
906 x 2100	1025 x 2159.5	924 x 2102	1045 x 2169.5
1006 x 2100	1125 x 2159.5	1024 x 2102	1145 x 2169.5

\* external dimensions of doorframe, including anchors

C – width of door leaf

L – door leaf height

E – total width of doorframe

H – total height of doorframe

D – net walk-through width of doorframe

J – net walk-through height of doorframe





# Concealed doorframe

## AKTIVE PP 40/00

### for SAPELI flame-resistant doors

The gap between the doorframe and leaf is 3 mm, and the gap between the floor and door leaf is 7 mm.

Standard clear passage is 1970 mm and 2100 mm. Nonstandard dimensions from 1975 mm to 2200 mm.

The maximum dimensions of a flame-resistant doorframe are 1000 x 2200 mm with an option for custom modification in dimensions beyond 5 mm.

The doorframe is intended for a final minimum partition thickness of 125 mm or greater. The hole must be provided with a lintel — the doorframe cannot bear a load.

#### METAL FITTINGS

---

- Tectus 340 hinge
- flat stainless-steel counter-plate for EI30 resistance
- flat stainless-steel counter-plate for EI30 resistance + 2 added flat stainless-steel counter-plates for RC2 resistance

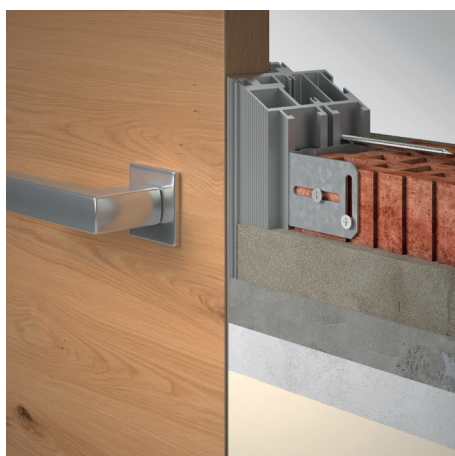
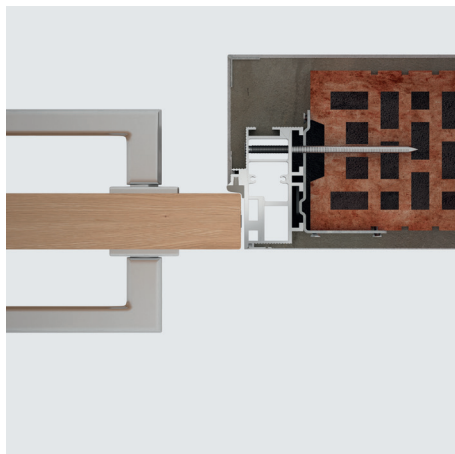
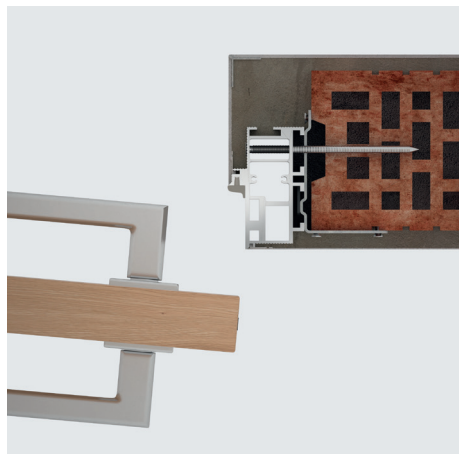

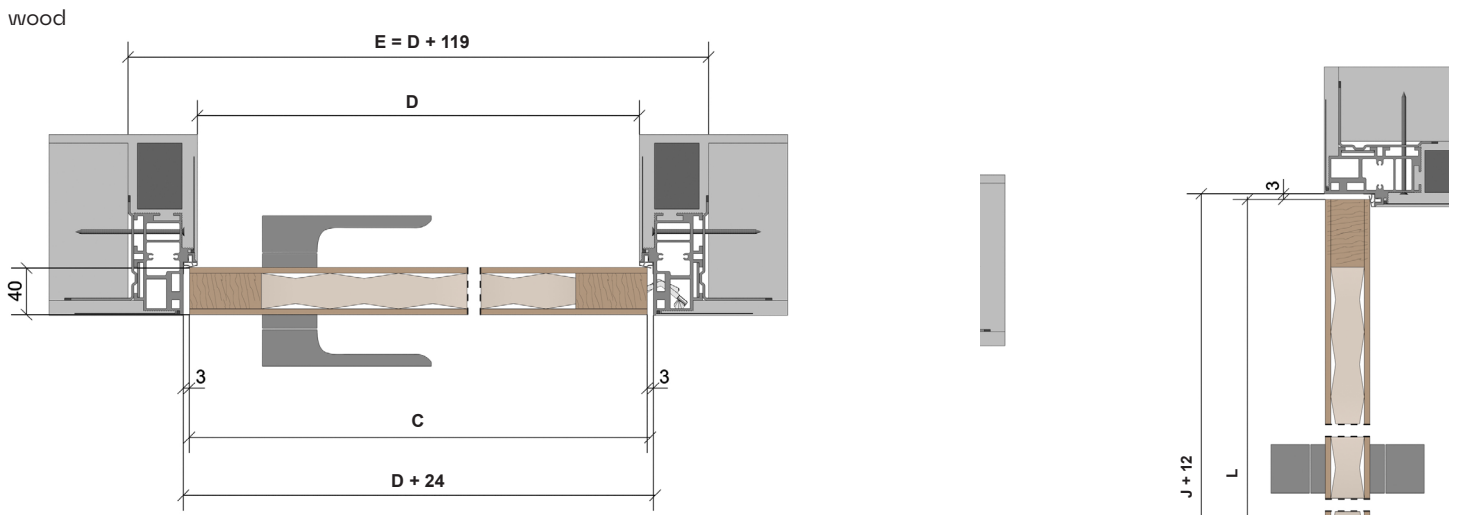

detail

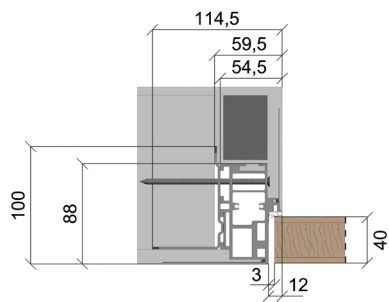

- C – width of door leaf
- L – door leaf height
- E – total width of doorframe
- H – total height of doorframe
- D – net walk-through width of doorframe
- J – net walk-through height of doorframe

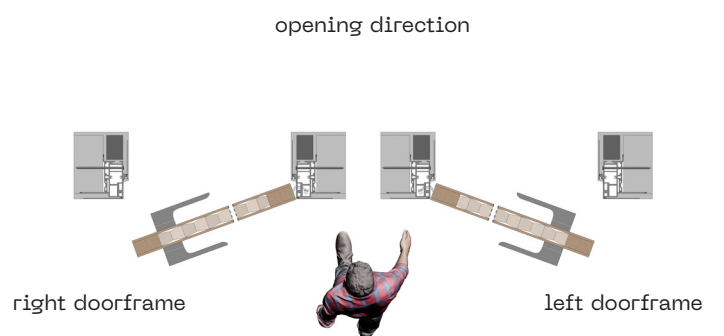



# Concealed doorframes Model DUAL

DUAL concealed doorframe



# The concealed doorframe allows doors to open in both directions, push and pull, at the same time.

- Intended for MASTER and wooden doors 40 mm thick
- Used for drywall and masonry
- The doorframe is equipped with 2 hinges and a counter-plate
- The doorframe is fitted with a soft PVC seal for silent closing
- We offer max doorframe widths to 1100 mm and max height 2500 mm
- We also produce non-standard dimensions, both widths and heights
- Cannot be added without a door header, or with a slanted end toward the attic
- The doorframes are made of anodized aluminium or in RAL K7, NCS and CREATIVE METALLIC colours
- 5-year warranty
- Made in the Czech Republic

DUAL



# Concealed doorframe

## Model DUAL

### For MASTER doors

All dimensions are in millimetres.

Thickness of door leaf: 40.

#### DUAL 1970 mm

Height of net passage after installation of doorframe (J): 1970.

Total height of doorframe (H): 2017.

Standard height of the door leaf (L): 1961.5.

Net passage after installing doorframe D x J	Total dimensions of revolving doorframe E x H*	Standard dimensions of revolving leaf C x L	Recommended dimensions of rough construction opening
602 x 1970	695 x 2017	597 x 1961.5	715 x 2027
702 x 1970	795 x 2017	697 x 1961.5	815 x 2027
802 x 1970	895 x 2017	797 x 1961.5	915 x 2027
902 x 1970	995 x 2017	897 x 1961.5	1015 x 2027
1002 x 1970	1095 x 2017	997 x 1961.5	1115 x 2027

#### DUAL 2100 mm

Height of net passage after installation of doorframe (J): 2100.

Total height of doorframe (H): 2147

Standard height of the door leaf (L): 2091.5.

Net passage after installing doorframe D x J	Total dimensions of revolving doorframe E x H*	Standard dimensions of revolving leaf C x L	Recommended dimensions of rough construction opening
602 x 2100	695 x 2147	597 x 2091.5	715 x 2157
702 x 2100	795 x 2147	697 x 2091.5	815 x 2157
802 x 2100	895 x 2147	797 x 2091.5	915 x 2157
902 x 2100	995 x 2147	897 x 2091.5	1015 x 2157
1002 x 2100	1095 x 2147	997 x 2091.5	1115 x 2157

\* external dimensions of doorframe, including anchors

C – width of door leaf

L – door leaf height

E – total width of doorframe

H – total height of doorframe

D – net walk-through width of doorframe

J – net walk-through height of doorframe





# Concealed doorframe

## Model DUAL

### For MASTER doors

The gap between the doorframe and leaf is 2.5 mm, and the gap between the floor and door leaf is 6 mm.

Standard clear passage is 1970 mm and 2100 mm. Nonstandard dimensions from 1975 mm to 2500 mm.

When using anchors, the doorframe is intended for a final partition thickness of 125 mm or greater. The hole must be provided with a lintel — the doorframe cannot bear a load.

#### METAL FITTINGS

---

- DUAL hinge
- HOBES short magnetic counter-plate
- HOBES long magnetic counter-plate, long for locking
- M&T magnetic counter-plate (cylindrical, deadbolt, WC)

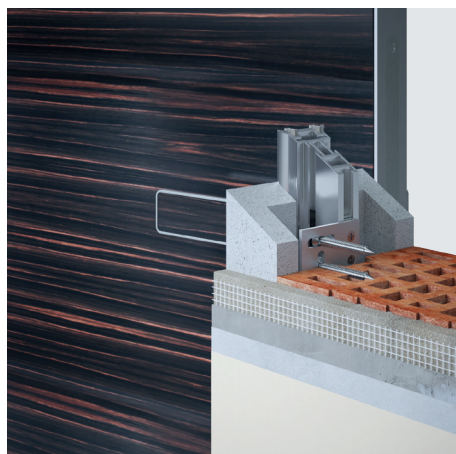
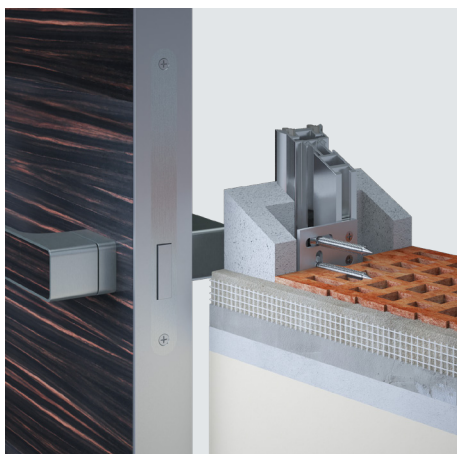
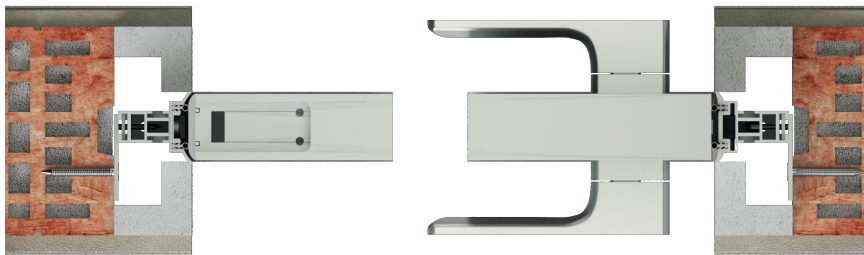

# DOORFRAME SOLUTION OPTIONS

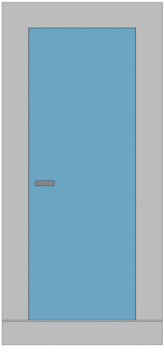

MASTER

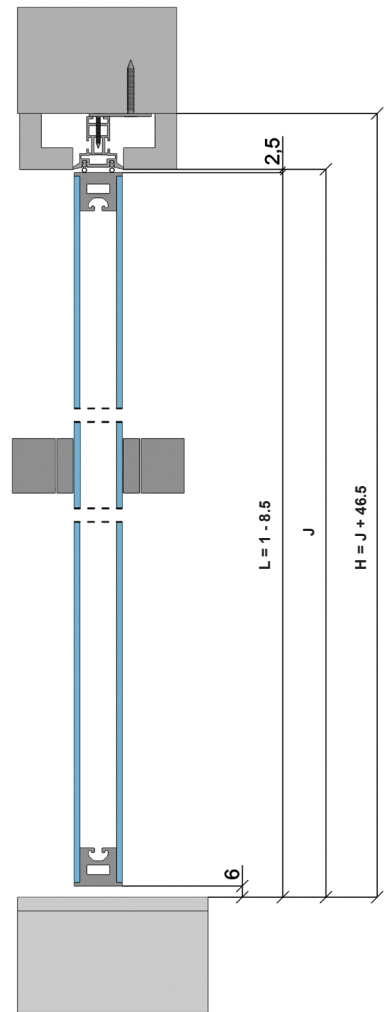
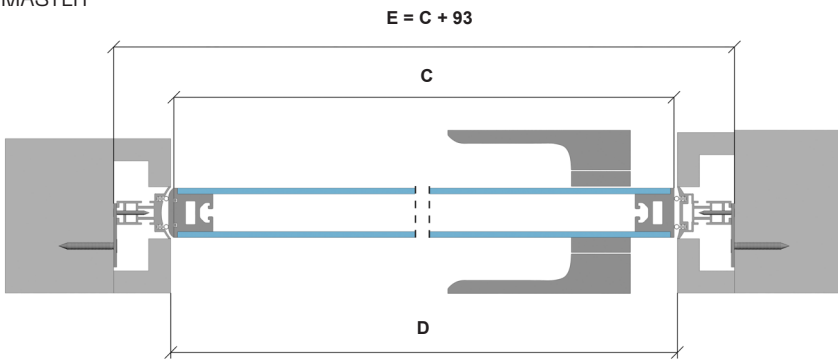

detail

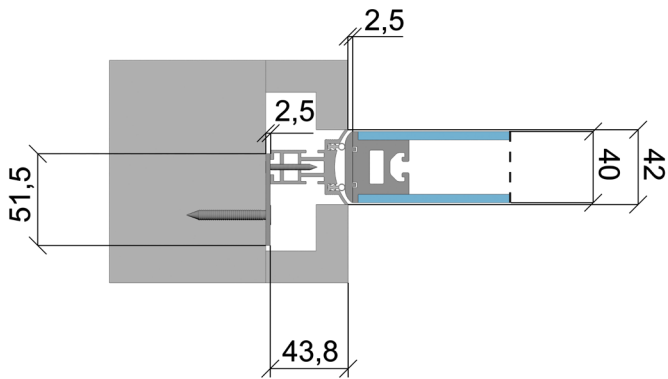

- C – width of door leaf
- L – door leaf height
- E – total width of doorframe
- H – total height of doorframe
- D – net walk-through width of doorframe
- J – net walk-through height of doorframe

opening direction

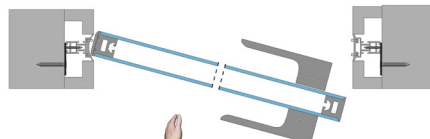

right doorframe

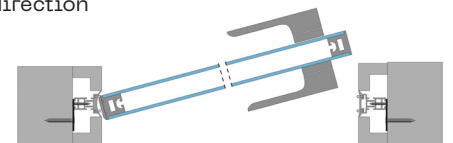

left doorframe



# Counter doorframe LATENTE MODEL

LATENTE concealed doorframe



The LATENTE counter doorframe is an edger tool that defines the construction opening and allows installation of a LATENTE mounting panel doorframe, which has a nonstandard thickness of 15 mm (we produce only a counter doorframe, and the door manufacturer supplies the mounting panel doorframe).

- The passage around the door is delimited by the doorframe, which is flush with the wall
- The counter doorframe is made of 22 mm thick particle board panels and raw aluminium profile
- The counter doorframe is for pull opening the door from the flush viewing side (traditional)
- The counter doorframe is for non-rebated doors, with a total thickness of 40 mm
- Standard for Latente counter doorframes is a 50 mm mounting panel with a 12 mm half track and a 2.5 mm shadow groove (SAPELI)
- Used for drywall and masonry
- The counter doorframe comes in heights up to 2700 mm
- The passage width is produced based on customer request
- Intended for single-leaf and double-leaf doors
- Delivered unassembled and must be assembled before installation
- 5-year warranty on doorframe
- Made in the Czech Republic

LATENTE



DETAIL OF HORIZONTAL SECTION

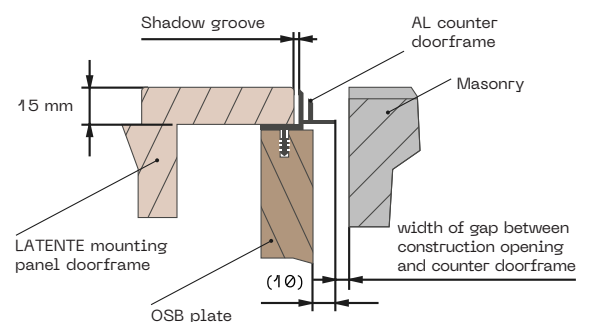



# Mounting panel doorframe Model DYNAMIK

DYNAMIK doorframe model BETA





# Additional assemblable aluminium mounting panel doorframe for walls 85–210 mm thick.

- For wider partitions, can be installed at the corner of the construction opening
- The doorframes are made from anodized aluminium, with a painted option based on the RAL, K7, NCS or Creative Metallic swatch books.
- This doorframe is suitable for business spaces or humid environments.
- For masonry, drywall and concrete partitions
- For non-rebated doors 40 mm thick (wooden or Master) or for all-glass doors.
- For side window and transom panels, can be 6–20 mm thick, especially tempered glass.
- Standard passages for Dynamik doorframes 600–1000 x 1970 and 2100 mm, other dimensions are nonstandard
- The maximum passage offered for single-leaf doors is 1102 x 2700 mm, and for double-leaf doors 2056 x 2700 mm.
- The maximum side window panel dimension is 1000 x 2700 mm

# DYNAMIK ALFA

## For wooden doors

All dimensions are in millimetres.

Thickness of door leaf – non-rebated: 40.

### DYNAMIK ALFA 1970 mm

Height of net passage after installation of doorframe (J): 1970.

Total height of doorframe (H): 2035.

Standard height of the door leaf (L): 1975.

Net passage after installing doorframe D x J	Total dimensions of revolving doorframe E x H*	Standard dimensions of revolving leaf C x L	Wall thickness
602 x 1970	732 x 2035	626 x 1975	85–210
702 x 1970	832 x 2035	726 x 1975	85–210
802 x 1970	932 x 2035	826 x 1975	85–210
902 x 1970	1032 x 2035	926 x 1975	85–210
1002 x 1970	1132 x 2035	1026 x 1975	85–210
1102 x 1970	1232 x 2035	1126 x 1975	85–210

### DYNAMIK ALFA 2100 mm

Height of net passage after installation of doorframe (J): 2100.

Total height of doorframe (H): 2165

Standard height of the door leaf (L): 2105.

Net passage after installing doorframe D x J	Total dimensions of revolving doorframe E x H*	Standard dimensions of revolving leaf C x L	Wall thickness
602 x 2100	732 x 2165	626 x 2105	85–210
702 x 2100	832 x 2165	726 x 2105	85–210
802 x 2100	932 x 2165	826 x 2105	85–210
902 x 2100	1032 x 2165	926 x 2105	85–210
1002 x 2100	1132 x 2165	1026 x 2105	85–210
1102 x 2100	1232 x 2165	1126 x 2105	85–210

\* external dimensions of doorframe, including anchors

C – width of door leaf

L – door leaf height

E – total width of doorframe

H – total height of doorframe

D – net walk-through width of doorframe

J – net walk-through height of doorframe





# DYNAMIK ALFA

## For wooden doors

The gap between the doorframe and leaf is 3 mm, and the gap between the floor and door leaf is 7 mm.

Standard clear passage is 1970 mm and 2100 mm. Nonstandard dimensions from 1970 mm to 3700 mm. The hole must be provided with a lintel — the doorframe cannot bear a load.

### METAL FITTINGS

- Tectus 340 hinge
- M&T magnetic adjustable counter-plate
- magnetic counter-plate for SAPELI doors
- shortened magnetic counter-plate for SAPELI doors
- magnetic lock (cylindrical, deadbolt, WC)
- self-closing device\*
- Argenta NEO – M6
- HOBES short magnetic counter-plate
- HOBES magnetic counter-plate, long for locking

\* Always after consulting the sales representative.

DYNAMIK for walls 85–210 mm thick

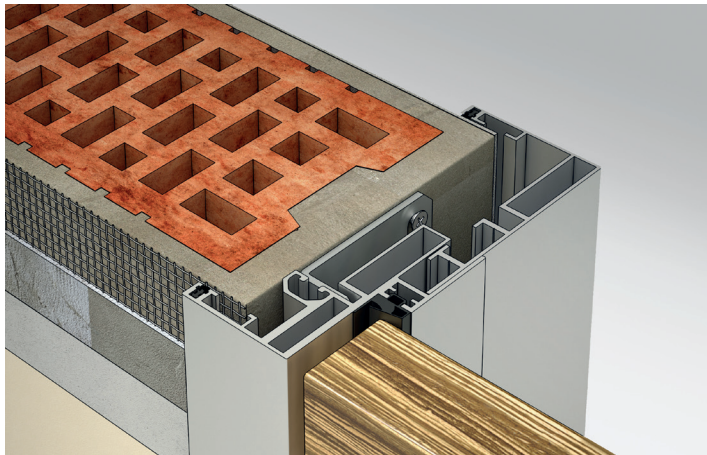

DYNAMIK for walls 85–210 mm thick

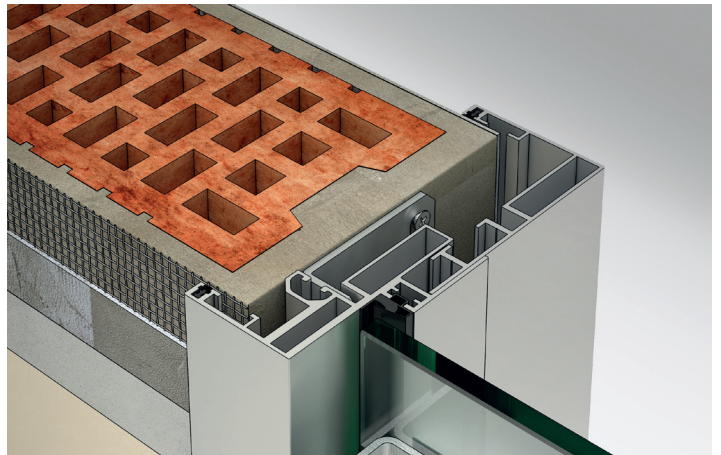

DYNAMIK for walls over 210 mm thick

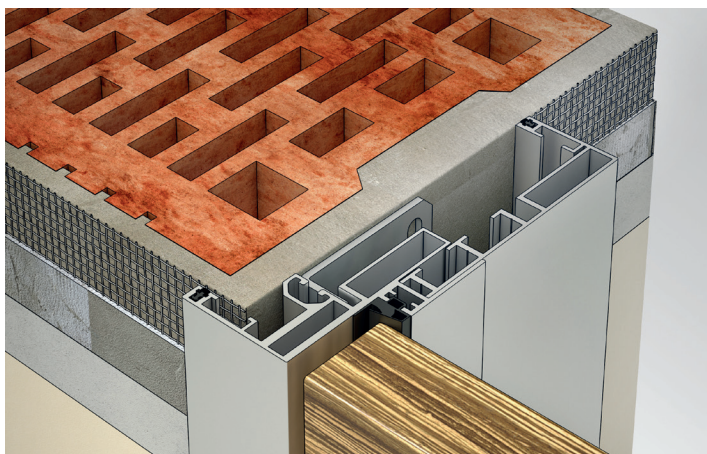

DYNAMIK for walls over 210 mm thick



# DOORFRAME SOLUTION OPTIONS

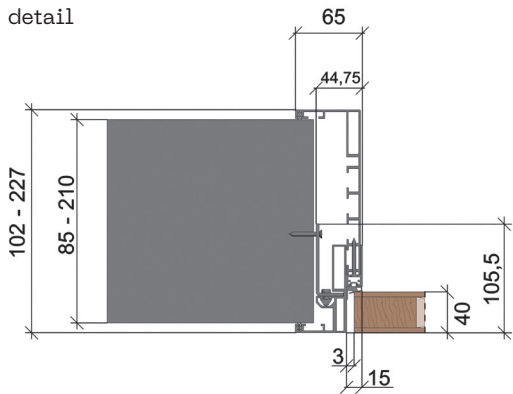
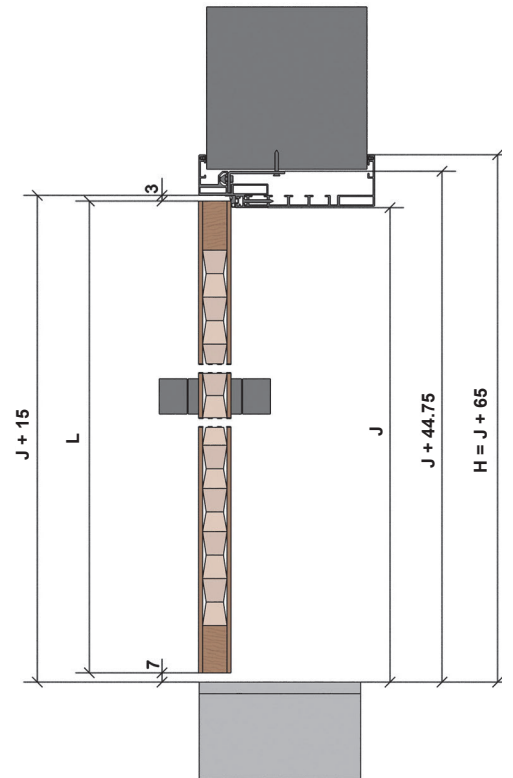
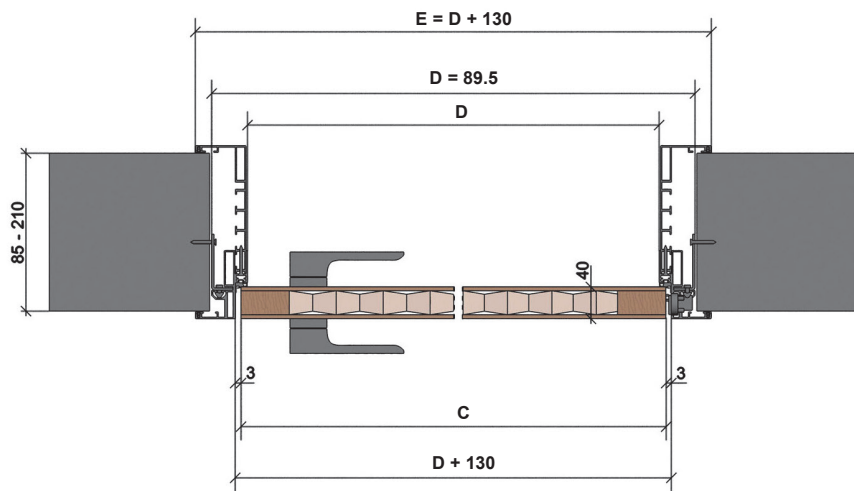
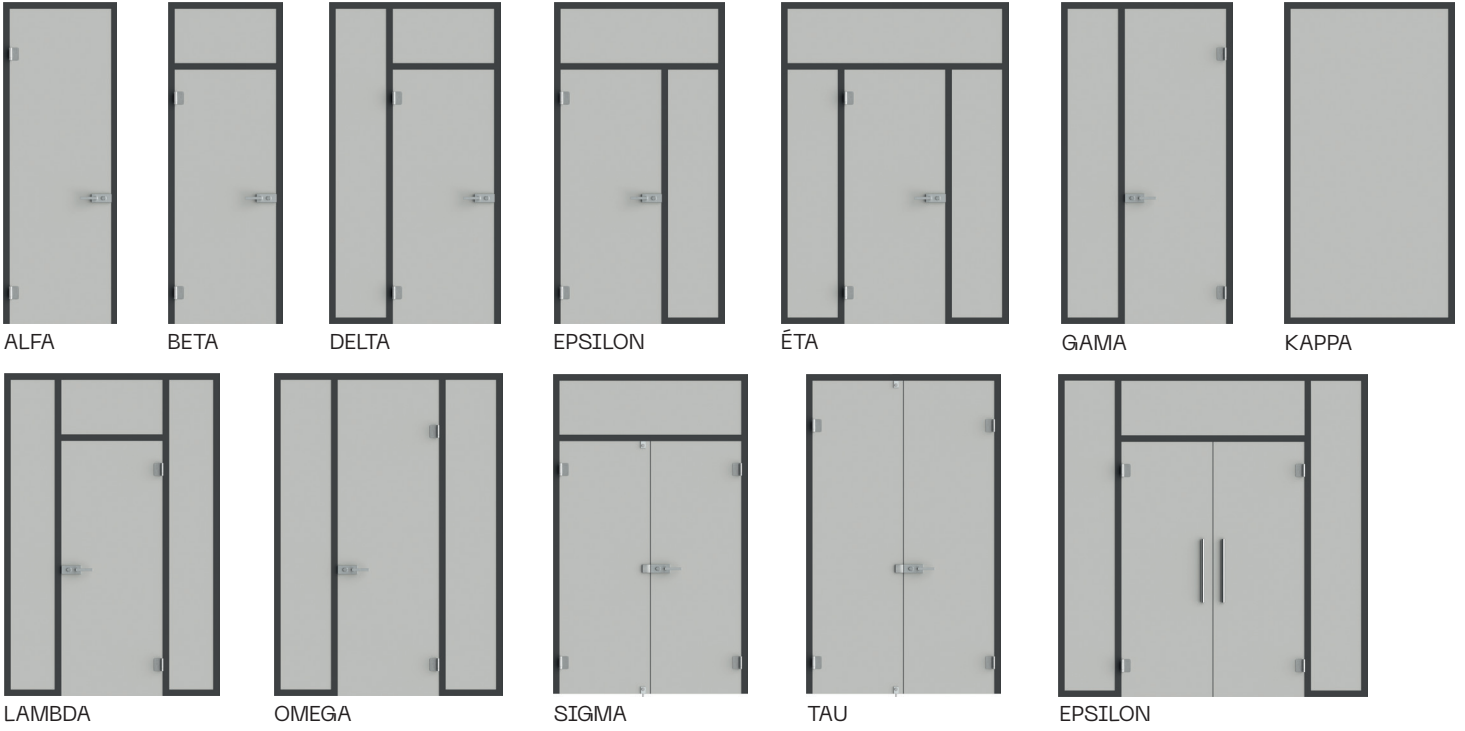

- C – width of door leaf
- L – door leaf height
- D – net walk-through width of doorframe
- J – net walk-through height of doorframe

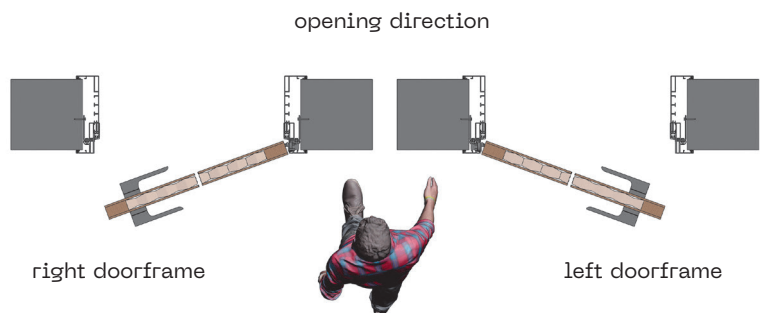



# SKIRTING BOARD

Skirting board





We supply two types of skirting boards: recessed with aluminium cover profile or lining for floor covering (tile, linoleum, floating floor, etc.). Allows full opening of door leaves with concealed doorframes.

- Intended for concealed doorframes 40/00 + 25/15 •
- Recessed version with aluminium cover profile for drywall and masonry • Recessed version floor covering is intended only for plaster walls • The supporting skirting profile serves as a screed for evening the plaster or drywall • The recessed plinth with aluminium cover profile can be equipped with LEDs (not included), and an electrical installation can be added •
- The recessed plinth for floor covering can be set with tile, linoleum, a floating floor, etc, to a maximum thickness of 9 mm •
- Skirting profiles can be connected using 90° or 180° skirting connectors •
- Supplied in a max standard length of 6000 mm •
- The surface finish of the plinths is RAL, K7, NCS or CREATIVE METALLIC •
- The warranty for skirting boards is 5 years

# SKIRTING BOARD

## with visible anodized aluminium cover profile

The recessed skirting board consists of two anodized aluminium profiles, a lining anchor profile and a visible cover profile that can be finished according to customer request in NCS, RAL K7 or metallic colours.

Cables or LEDs can be placed in the skirting boards (lights not included).

# SKIRTING BOARD

## with floor covering

This version is for customers who want a recessed skirting board in the same design and material as the floor. Here the maximum thickness of the material used, including adhesive, is 9 mm. When ordering concealed doorframes, it is important to indicate that this skirting board is used. This is because the concealed doorframes must be milled at the bottom so that the skirting board can be installed tightly to the passage part of the doorframe profile.

### Skirting board for plaster wall with tiles

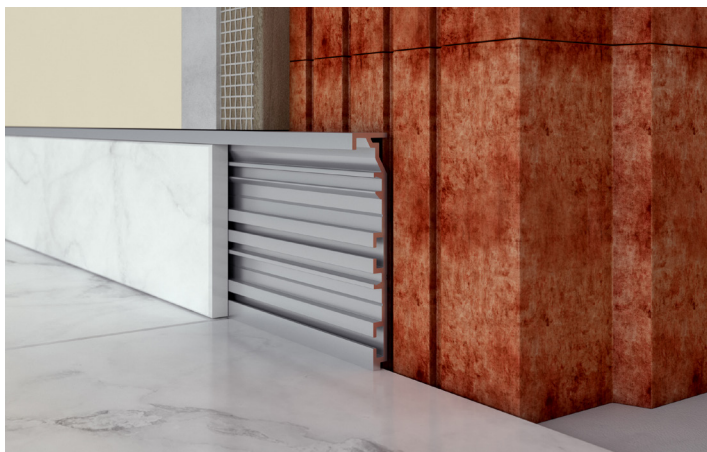

### Skirting board with aluminium

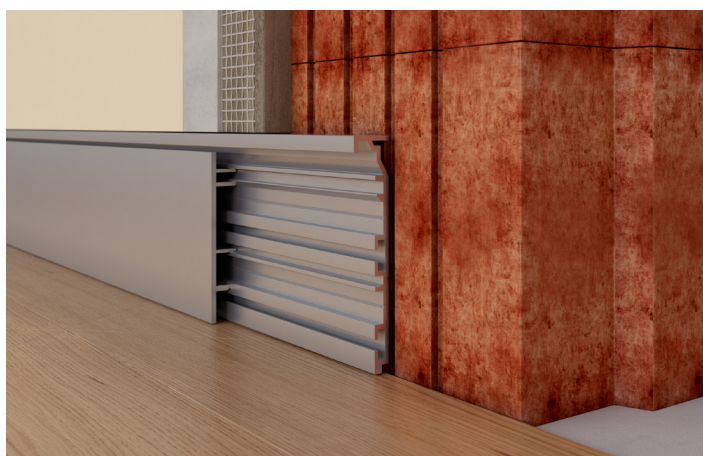

# CONNECTOR TYPES FOR RECESSED SKIRTING BOARDS

- INNER CONNECTOR TO 90°/ OUTER CONNECTOR TO 90°

Invisible for recessed profile when the subsequent pieces are cut below a 45° angle.

Order number: MJPVC01

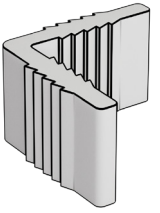

- CONNECTOR TO 180°

Invisible for recessed profile when the subsequent pieces are cut below a 90° angle (perpendicular to each other).

Order number: MJPVC02

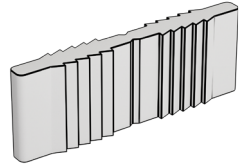

- CONNECTOR TO 90° INTERNAL

Visible for visible profile when the subsequent pieces are cut.

Connectors can be added in any colour from the RAL, K7, NCS or Creative Metallic swatch books.

Order number: MJPVC06



- CONNECTOR TO 90° EXTERNAL

Visible for visible profile when the subsequent pieces are cut below a 45° angle. Connectors can be added in any colour from the RAL, K7, NCS or Creative Metallic swatch books.

Order number: MJPVC05



- PLINTH ENDS

If the plinth extends into the space, an end can be used on it, only for the visible profile. The end can be right or left. Ends can be added in any colour from the RAL, K7, NCS or Creative Metallic swatch books.

Order number for right end: MJPVC08

Order number for left end: MJPVC07

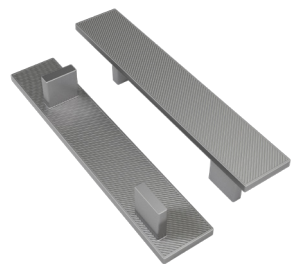



# METAL FITTINGS

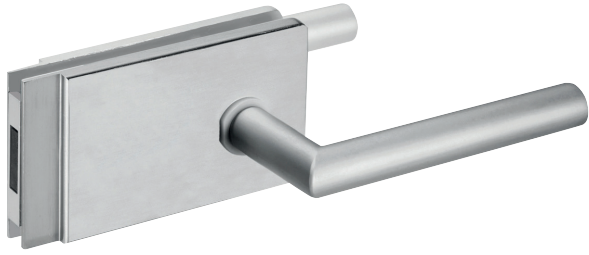

MAGNETIK door handle without lock  
(aluminium, anodized)  
Z8000017

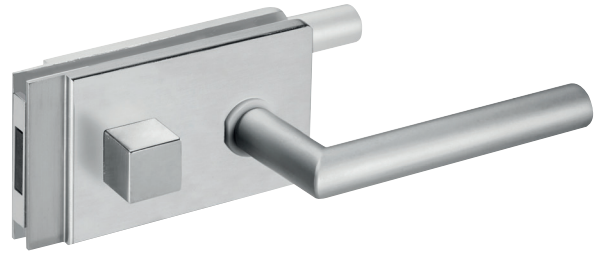

MAGNETIK WC door handle  
(aluminium, anodized)  
Z8000018



FINE DOOR HANDLE (aluminium, anodized)  
ZLKHOP02



GRANDE DOOR HANDLE (AL elox)  
ZLKHOP01



MINIMAL door handle (SNI polished)  
ZLKMINSNI



MAXIMAL door handle (SNI polished)  
Z8000002



HORIZONT hinge  
(stainless steel/anodized aluminium)  
Z8010014

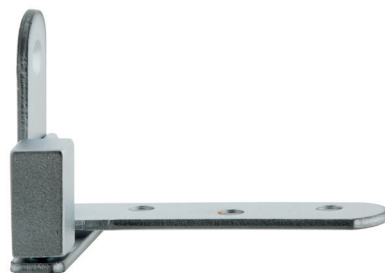

SFS CAB SQUARE  
pin hinge lower  
Z8050090



SFS CAB SQUARE pin hinge upper  
Z8050090



MINIMAL cylindrical rosette (SNI polished)  
ZROCYMIN02



MINIMAL deadbolt rosette (SNI polished)  
ZRODOMIN03



MINIMAL WC rosette (SNI polished)  
ZROWCMIN01



FLAT hinge (stainless steel)  
Z8010005



GARDE hinge  
P58PG003



DUAL hinge  
P58PN023

# METAL FITTINGS



Magnetically adjustable counter-plate  
ZPRMRZ01



shortened magnetic counter-plate  
ZPRMZK



high stainless-steel counter-plate  
MJPRNDD

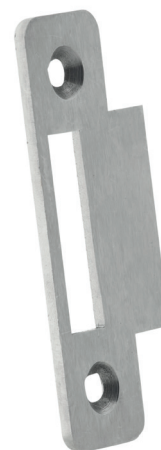

low stainless-steel counter-plate  
MJPRNKS08 / MJPRNKS10 / MJPRNKS12



long magnetic counter-plate  
ZPRMST



HOBES magnetic lock, cylindrical/deadbolt/WC  
ZZAMAGHOB003





Argenta NEO – M6  
ZPAARGE01

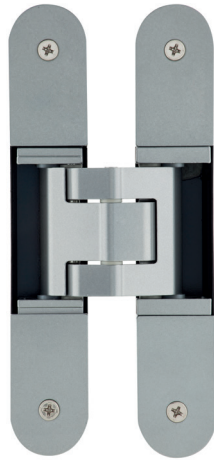

TECTUS 340 hinge  
ZPATEC340



TECTUS 240 hinge  
ZPATEC240







# CONCEALED DOORFRAMES LATENTE, DYNAMIK DOORFRAME AND SKIRTING BOARD

**JAP**

## HEADQUARTERS AND SHOWROOM

JAP FUTURE s.r.o.  
Nivky 67  
750 02 Přeřov III – Lověšice

+420 581 587 847  
export@japcz.cz  
www.japcz.cz/en

## PRAGUE SHOWROOM

Českomoravská 183/27  
(Sykora Home)  
190 00 Prague 9 – Vysočany  
+420 739 278 160  
praha@japcz.cz